

# Kitchen Ventilation



# When your home breathes, you breathe easier too.



## **Kitchen Ventilation**

removes cooking effluents during food preparation to eliminate airborne pollutants from spreading through the entire house.



## **Fresh Air Systems**

efficiently exchange inside air with fresh outside air, and remove airborne particulate with HEPA filtration.



## **Exhaust Ventilation**

removes excess moisture and odor from any room in the home, and can also provide continuous, whole-house ventilation.

### **Broan-NuTone can improve indoor air quality in every room of the home.**

From clearing humidity in the bathroom to removing steam and other airborne effluents in the kitchen, no company knows residential and light commercial ventilation like Broan-NuTone. After countless innovations and a commitment to indoor air quality, trust Broan-NuTone to clear up every concern.

# Why indoor air quality is important to you.

Not all homeowners recognize what contributes to poor indoor air quality, the potential effects and harm, and how to address these problems. Broan-NuTone® is here to help. For nearly 90 years, Broan-NuTone has led the industry with residential ventilation solutions that improve indoor air quality and provide healthier home environments.

- 2 Ventilation Overview
- 4 Why Kitchens Need Ventilation
- 8 Chimney & Island Hoods
- 22 High Performance Hoods
- 28 Power Pack Inserts
- 40 Built-in Downdrafts
- 42 ENERGY STAR® Hoods
- 48 Under Cabinet Hoods
- 70 Accessories
- 74 Blowers/Installation Guidelines
- 76 Specifications



## Moisture

that is not properly ventilated can cause mildew and mold formation, potentially leading to structural and health problems. Exhaust ventilation solutions from Broan-NuTone remove humidity at the source to help maintain the optimal humidity balance of 40–60%.



## Off-gassing

from construction materials, carpeting, adhesives and synthetic materials—as well as solvents from common household cleaners—can accumulate in tightly built homes. Look to Broan-NuTone for continuous ventilation solutions that meet ASHRAE 62.2.



## Particulates

from dust, allergens, pet dander, and more can contribute to poor indoor air quality up to 100 times dirtier than outside air. A properly ventilated home creates a more enjoyable, comfortable and healthier environment.



## Cooking effluents

can infiltrate the whole house in minutes. Grease, oils and aromas settle permanently into carpets, furniture, clothing and other surfaces. Kitchen ventilation solutions help eliminate cooking effluents for a cleaner, more comfortable and healthier environment.

## America's most used and trusted residential ventilation company.

Broan-NuTone is proud to have our American-made ventilation and home comfort and convenience products installed in 90 million homes across the country.



# Every kitchen needs ventilation. Here's why.

The fact is, the kitchen is a primary source of poor indoor air quality. Excessive moisture, smoke, and air-borne particulate quickly infiltrates every room in your home. Indoor air can be up to 100 times more polluted than outside air, which means adequate ventilation is critical to a more comfortable and healthier environment. Broan has performance matched ventilation solutions for every cooking style and the type of appliance beneath it. Whether it's a focal point in your kitchen, or concealed in custom cabinetry, trust Broan—the leader in residential ventilation—to provide the optimal solution.



# Broan range hoods. The best solution for faster smoke and odor removal.

**A microwave oven has its purpose. And so does a range hood.**

While it may seem like you're tackling two problems with one appliance, there's always give and take. The ventilating capability of an over-the-range microwave simply doesn't compare to Broan kitchen ventilation. The purposeful design of Broan range hoods allows faster, more effective removal of smoke, odors and particulates for improved indoor air quality, and a cleaner kitchen.

**The Broan Captur™ Ventilation System ensures unsurpassed performance.**

When we set out to improve every aspect of kitchen ventilation, removing heat, smoke and moisture was key. After all, according to the EPA, the kitchen is one of the primary sources of indoor air quality problems—capturing and removing cooking effluents at the source is critical. So we looked at everything, inside and out. The blower wheel and motor assembly are designed to move more air with greater efficiency, unique filters capture effectively without restricting airflow, and new hood shapes provide effective coverage over all burners. All of which mean better performance, quieter operation and less energy use.

**Captur™**

For faster smoke and odor removal.



Shown: Sahale range hood featuring the Captur™ system with three pots boiling, versus a microwave with two pots boiling.



**The right range hood and accessories for your cooking style, design sense, and easy installation.**





**Chimney Hoods. Do you have an open-concept kitchen?**

Consider a chimney style range hood to create a stunning focal point. Choose wall-mounted designs or a suspended range hood over an island cooktop. Be sure the blower you select matches the BTU output of your range.



**High Performance Hoods. Looking for convenience in a high performance range hood?**

Style, power and modern convenience are possible with high-performance hoods. Highly effective filtration and stainless steel bottoms make cleaning easy. Just match your blower to the BTU output of your range.



**Under Cabinet Hoods. In need of power while preserving cabinet space?**

The under cabinet range hood is the most popular type. You'll also find great styles in appliance-matching finishes, different performance levels and attractive price points.



**Power Pack Inserts. Thinking of designing custom cabinetry?**

Power pack inserts allow you to conceal your range hood inside a cabinet for a clean look. Insert a power pack and achieve all the benefits of great ventilation.



**Downdrafts. Looking for a range hood that's there when you need it and hidden when you don't?**

Downdraft range hoods are perfect for island or peninsula installations. You receive the right amount of ventilation literally at the push of a button.





Shown: EW54 on page 17

# Chimney & Island

Every room deserves a focal point. In the kitchen, achieve it with Broan Chimney & Island range hoods. Strong angles, gentle curves, glass accents, striking lighting. Details make all the difference, and that says something about you.





## EW48



**STAINLESS**  
24" 30" 36"  
EW4824SS  
EW4830SS  
EW4836SS



**BLACK STAINLESS**  
30" 36"  
EW4830BLS  
EW4836BLS

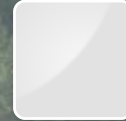

**WHITE**  
30"  
EW4830WH

**This beautiful, traditional European design** brings an exciting new look to your kitchen. Quiet operation and bright LED lighting enhances your cooking experience, while the sleek 3-speed capacitive touch control makes operation and clean-up easy.

- Quiet 460 MAX Blower CFM operates at a best-in-class 1.5 sones at normal speed.
- Bright 2-level LED module (included).
- Tap-touch, three-speed capacitive control features a smooth, easy-to-clean surface.
- Dishwasher-safe deluxe filters feature quick-release latch for easy removal.
- CRT provides the ability to meet codes and reduce airflow to 300 CFM.
- 10 minute delay-off function keeps hood running after cooking to ensure smoke and odors have cleared the environment.
- Optional non-duct recirculation kit and filters available.
- Ducted/non-ducted telescopic flue extension accommodates 8' to 9' ceiling heights. Flue extensions available to accommodate ceiling heights from 9' to 10'.
- Installation brackets are included for easy installation.

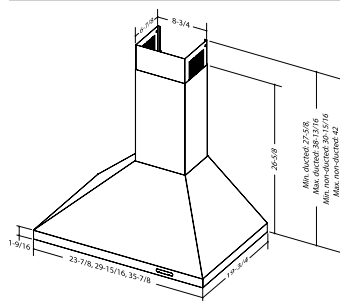

Install the hood so that the bottom of the unit is 24" to 30" above the cooking surface. Mounting height may be affected by ceiling height.

### SPECIFICATIONS

Width	MAX Blower CFM*	Blower	Sones†	Volts	Amps	Duct	10' Flue Extension	Non-duct Kit	Non-duct Replacement Filter
24" 30" 36"	460	Internal	1.5	120	1.53	6" RD	AEEW48SS AEEW48WH AEEW48BLS	ARKEW48	S99010473; 24", 30" S99010474; 36"

\* MAX Blower CFM indicates hood blower performance in open air. Find HVI rated performance for this model in the product specification sheet at Broan-NuTone.com

† Sones at normal (or working) speed.

### OPTIONAL ACCESSORIES

**BROAN** *Elite*





EW46



STAINLESS  
30" 36"  
EW4630SS  
EW4636SS



**Elegant, curved glass design** provides a stunning focal point for any kitchen. Quiet operation and bright LED lighting enhances your cooking experience, while the sleek 3-speed capacitive touch control makes operation and clean-up easy.

- Quiet 460 MAX Blower CFM operates at a best-in-class 1.5 sones at normal speed.
- Bright 2-level LED module (included).
- Tap-touch, three-speed capacitive control features a smooth, easy-to-clean surface.
- Dishwasher-safe deluxe filters feature quick-release latch for easy removal.
- CRT provides the ability to meet codes and reduce airflow to 300 CFM.
- 10 minute delay-off function keeps hood running after cooking to ensure smoke and odors have cleared the environment.
- Optional non-duct recirculation kit and filters available.
- Ducted/non-ducted telescopic flue extension accommodates 8' to 9' ceiling heights. Flue extensions available to accommodate ceiling heights from 9' to 10'.
- Installation brackets are included for easy installation.

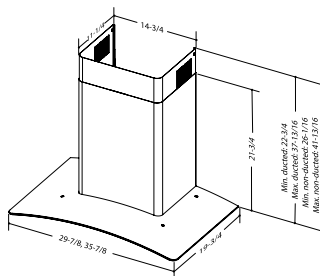

**SPECIFICATIONS**

Width	MAX Blower CFM*	Blower	Sones†	Volts	Amps	Duct
30" 36"	460	Internal	1.5	120	1.53	6" RD

**OPTIONAL ACCESSORIES**

10' Flue Extension	Non-duct Kit	Non-duct Replacement Filter
AEEW46SS	ARKEW46	S99010475

\* MAX Blower CFM indicates hood blower performance in open air. Find HVI rated performance for this model in the product specification sheet at Broan-NuTone.com  
† Sones at normal (or working) speed.

Install the hood so that the bottom of the unit is 24" to 30" above the cooking surface. Mounting height may be affected by ceiling height.

CHIMNEY & ISLAND





## EW43



**STAINLESS**  
24" 30" 36"  
EW4324SS  
EW4330SS  
EW4336SS



**BLACK STAINLESS**  
30" 36"  
EW4330BLS  
EW4336BLS

**Elegant, clean lines** form to create a sophisticated contemporary design that's perfect for today's modern kitchens. Quiet operation and bright LED lighting enhances your cooking experience, while the sleek 3-speed capacitive touch control makes operation and clean-up easy.

- Quiet 460 MAX Blower CFM operates at a best-in-class 1.5 sones at normal speed.
- Bright 2-level LED module (included).
- Tap-touch, three-speed capacitive control features a smooth, easy-to-clean surface.
- Dishwasher-safe deluxe filters feature quick-release latch for easy removal.
- CRT provides the ability to meet codes and reduce airflow to 300 CFM.
- 10 minute delay-off function keeps hood running after cooking to ensure smoke and odors have cleared the environment.
- Optional non-duct recirculation kit and filters available.
- Ducted/non-ducted telescopic flue extension accommodates 8' to 9' ceiling heights. Flue extensions available to accommodate ceiling heights from 9' to 10'.
- Installation brackets are included for easy installation.

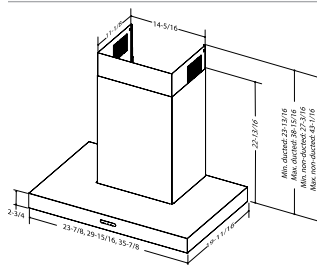

### SPECIFICATIONS

Width	MAX Blower CFM*	Blower	Sones†	Volts	Amps	Duct	10' Flue Extension	Non-duct Kit	Non-duct Replacement Filter
24" 30" 36"	460	Internal	1.5	120	1.53	6" RD	AEEW43SS AEEW43BLS	ARKEW43	S99010473; 24", 30" S99010474; 36"

\* MAX Blower CFM indicates hood blower performance in open air. Find HVI rated performance for this model in the product specification sheet at Broan-NuTone.com

† Sones at normal (or working) speed.

### OPTIONAL ACCESSORIES

Install the hood so that the bottom of the unit is 24" to 30" above the cooking surface. Mounting height may be affected by ceiling height.

**BROAN** *Elite*







## BWP2



**STAINLESS**  
24" 30" 36"  
450 MAX  
BLOWER  
CFM

BWP2244SS  
BWP2304SS  
BWP2364SS



**STAINLESS**  
30" 36"  
630 MAX  
BLOWER  
CFM

BWP2306SS  
BWP2366SS

### This hood offers traditional design with modern features.

Bright LED lighting enhances your cooking experience, while the 3-speed back-lit soft touch control makes operation easy.

- Choose a powerful 450 CFM or 630 CFM blower to match cooking surface output, or cooking style needs.
- 450 MAX Blower CFM operates at a quiet 3 sones at normal speed.
- 630 MAX Blower CFM operates at a quiet 1.5 sones at normal speed (BWP2306SS and BWP2366SS models only).
- Bright 1-level LED modules (included) enhance your cooking experience.
- 3-speed back-lit soft touch control for easy operation.
- Dishwasher-safe hybrid baffle filters feature quick-release latch for easy removal.
- 5 minute delay-off function keeps hood running after cooking to ensure smoke and odors have cleared the environment.
- Optional non-duct recirculation kit and filters are available for indoor exhaust recirculation to suit your needs.
- Ducted/non-ducted telescopic flue extension accommodates 8' to 9' ceiling heights. Flue extensions are available to accommodate ceiling heights from 9' to 10'.



Backlit mode when active.

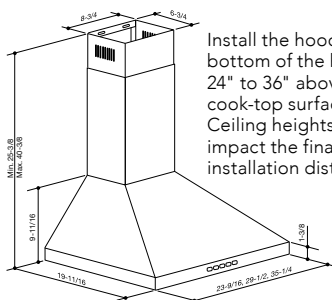

Install the hood so the bottom of the hood is 24" to 36" above the cook-top surface. Ceiling heights may impact the final installation distance.

#### SPECIFICATIONS (450 MAX Blower CFM)

Width	MAX Blower CFM*	Blower	Sones†	Volts	Amps	Duct
24" 30" 36"	450	Internal	3.0	120	2.6	6" RD

#### SPECIFICATIONS (630 MAX Blower CFM)

30" 36"	630	Internal	1.5	120	3.5	6" RD
---------	-----	----------	-----	-----	-----	-------

\* MAX Blower CFM indicates hood blower performance in open air. Find HVI rated performance for this model in the product specification sheet at Broan-NuTone.com

† Sones at normal (or working) speed.

#### OPTIONAL ACCESSORIES

10' Flue Extension	Non-duct Kit	Non-duct Replacement Filter
FXN58SS	ARKBWP	FILTERBWPTS





## BWS2



**STAINLESS**  
30"  
BWS2304SS



**BLACK STAINLESS**  
30"  
BWS2304BLS

**This sleek low-profile design** is the perfect statement for today's kitchens. Bright LED lighting enhances your cooking experience, while the 3-speed back-lit soft touch control makes operation easy.

- Powerful 450 MAX Blower CFM operates at a quiet 3 sones at normal speed.
- Bright 1-level LED modules (included) enhance your cooking experience.
- 3-speed back-lit soft touch control for easy operation.
- Dishwasher-safe hybrid baffle filters feature quick-release latch for easy removal.
- 5 minute delay-off function keeps hood running after cooking to ensure smoke and odors have cleared the environment.
- Optional non-duct recirculation kit and filters are available for indoor exhaust recirculation to suit your needs.
- Ducted/non-ducted telescopic flue extension accommodates 8' to 9' ceiling heights. Flue extensions are available to accommodate ceiling heights from 9' to 10'.



Backlit mode when active.

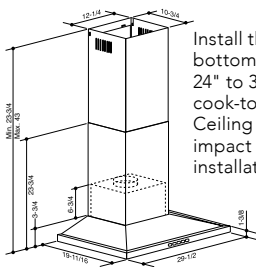

Install the hood so the bottom of the hood is 24" to 36" above the cook-top surface. Ceiling heights may impact the final installation distance.

### SPECIFICATIONS

Width	MAX Blower CFM*	Blower	Sones†	Volts	Amps	Duct
30"	450	Internal	3.0	120	2.6	6" RD

### OPTIONAL ACCESSORIES

10' Flue Extension	Non-duct Kit	Non-duct Replacement Filter
AEBWS AEBWSBLS	ARKBWTS	FILTERBWPTS

\* MAX Blower CFM indicates hood blower performance in open air. Find HVI rated performance for this model in the product specification sheet at Broan-NuTone.com

† Sones at normal (or working) speed.

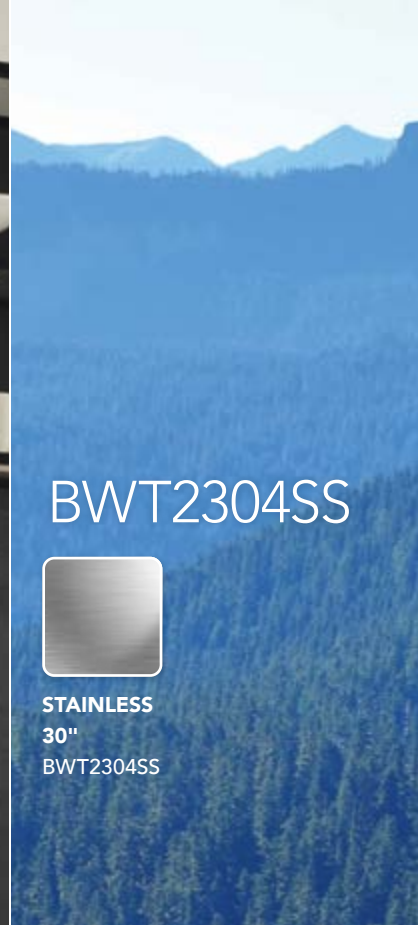

**Clean lines form to create a slim contemporary design** that's perfect for today's modern kitchens. Bright LED lighting enhances your cooking experience, while the 3-speed back-lit soft touch control makes operation easy.

- Powerful 450 MAX Blower CFM operates at a quiet 3 sones at normal speed.
- Bright 1-level LED modules (included) enhance your cooking experience.
- 3-speed back-lit soft touch control for easy operation.
- Dishwasher-safe hybrid baffle filters feature quick-release latch for easy removal.
- 5 minute delay-off function keeps hood running after cooking to ensure smoke and odors have cleared the environment.
- Optional non-duct recirculation kit and filters are available for indoor exhaust recirculation to suit your needs.
- Ducted/non-ducted telescopic flue extension accommodates 8' to 9' ceiling heights. Flue extensions are available to accommodate ceiling heights from 9' to 10'.



Backlit mode when active.

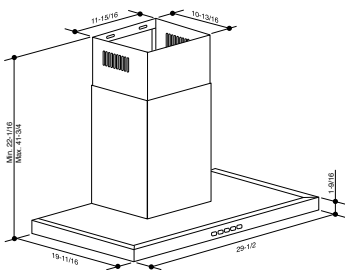

**SPECIFICATIONS**

Width	MAX Blower CFM*	Blower	Sones†	Volts	Amps	Duct
30"	450	Internal	3.0	120	2.6	6" RD

**OPTIONAL ACCESSORIES**

10' Flue Extension	Non-duct Kit	Non-duct Replacement Filter
FXN53SS	ARKBWTS	FILTERBWPTS

\* MAX Blower CFM indicates hood blower performance in open air. Find HVI rated performance for this model in the product specification sheet at Broan-NuTone.com  
 † Sones at normal (or working) speed.

Install the hood so the bottom of the hood is 24" to 36" above the cook-top surface. Ceiling heights may impact the final installation distance.



## BWT2304SSB



**STAINLESS**  
30"  
BWT2304SSB

**Clean lines form to create a slim contemporary design** surrounded by black glass that's perfect for today's modern kitchens. Bright LED lighting enhances your cooking experience, while the sleek 3-speed capacitive touch control makes operation and clean up easy.

- Powerful 450 MAX Blower CFM operates at a quiet 3 sones at normal speed.
- Bright 1-level LED modules (included) enhance your cooking experience.
- 3-speed capacitive touch control features a smooth, easy-to-clean surface.
- Dishwasher-safe hybrid baffle filters feature quick release latch for easy removal.
- 5 minute delay-off function keeps hood running after cooking to ensure smoke and odors have cleared the environment.
- Optional non-duct recirculation kit and filters are available for indoor exhaust recirculation to suit your needs.
- Ducted/non-ducted telescopic flue extension accommodates 8' to 9' ceiling heights. Flue extensions are available to accommodate ceiling heights from 9' to 10'.

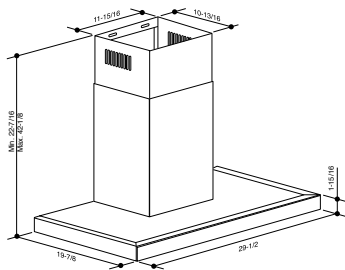

### SPECIFICATIONS

Width	MAX Blower CFM*	Blower	Sones†	Volts	Amps	Duct	10' Flue Extension	Non-duct Kit	Non-duct Replacement Filter
30"	450	Internal	3.0	120	2.6	6" RD	FXN53SS	ARKBWTS	FILTERBWPTS

\* MAX Blower CFM indicates hood blower performance in open air. Find HVI rated performance for this model in the product specification sheet at Broan-NuTone.com  
† Sones at normal (or working) speed.

### OPTIONAL ACCESSORIES

Install the hood so the bottom of the hood is 24" to 36" above the cook-top surface. Ceiling heights may impact the final installation distance.





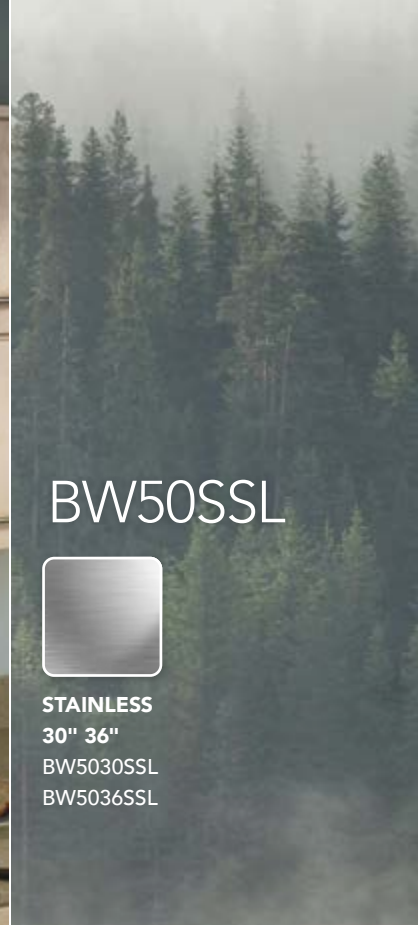

## BW50SSL



**STAINLESS**  
**30" 36"**  
 BW5030SSL  
 BW5036SSL

**Featuring a traditional design,** this chimney hood offers bright LED lighting that illuminates the cooktop.

- 380 MAX Blower CFM operates at a quiet 1.5 sones at normal speed.
- Bright 1-level LED modules (included) enhance your cooking experience.
- 3-speed push button controls make operation easy.
- Dishwasher-safe aluminum mesh filters feature quick-release latch for easy removal.
- Optional non-duct recirculation kit and filters are available for indoor exhaust recirculation to suit your needs.
- Ducted/non-ducted telescopic flue extension accommodates 8' to 9' ceiling heights. Flue extensions are available to accommodate ceiling heights from 9' to 10'.

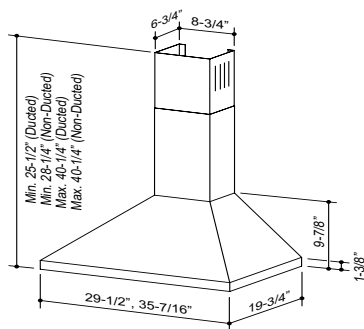

### SPECIFICATIONS

Width	MAX Blower CFM*	Blower	Sones†	Volts	Amps	Duct	10' Flue Extension	Non-duct Kit	Non-duct Replacement Filter
30" 36"	380	Internal	1.5	120	2.6	6" RD	FXN58SS	RK58	ROUNDFILTER

### OPTIONAL ACCESSORIES

\* MAX Blower CFM indicates hood blower performance in open air. Find HVI rated performance for this model in the product specification sheet at Broan-NuTone.com

† Sones at normal (or working) speed.

Install the hood so that the bottom of the unit is 30" above the cooking surface. Mounting height may be affected by ceiling height.





EW54



**BLACK  
STAINLESS**  
30" 36"  
EW5430BLS  
EW5436BLS

**A sleek, low-profile design enhanced by a dazzling new finish.**

Create a signature look and focal point in any kitchen with this stunning black stainless chimney hood.

- Compact chimney with contemporary flair.
- Dishwasher-safe micro-mesh filters provide highly efficient grease removal. The electronic filter clean reminder ensures they will always maintain peak efficiency.
- Black stainless steel finish.
- Optional non-duct recirculation kit available.
- Two widths 30" & 36"; in a 20" depth.
- Powerful internal 600 MAX Blower CFM operates at 1.5 sones at normal speed.
- Install hood so that the bottom of the unit is 24" to 30" above the cooking surface. Mounting height may be affected by ceiling height.
- Bright dual halogen lighting; 2-intensity settings (lamps included).
- Ducted telescopic flue accommodates ceiling heights from 8' to 9'. Flue extension for higher ceilings is also available.<sup>1</sup>
- Tap-touch, three-speed capacitive control features a smooth, easy-to-clean surface.

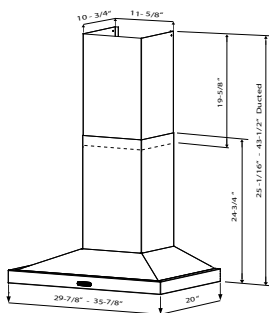

**SPECIFICATIONS**

Width	MAX Blower CFM*	Blower	Sones†	Volts	Amps	Duct
30", 36"	600**	Internal	1.5	120	4.8	6" RD 3-1/4" x 10"

**OPTIONAL ACCESSORIES**

Non-duct Kit	Non-ducted Filter	Ducted Flue Extension <sup>1</sup>	Make-Up Air Damper <sup>†</sup>
HRKMBSL	FILTERECM	FXE54BLS	MD6TU, MD8TU, MD10TU

<sup>1</sup> Optional flue extension for 10' ceiling.  
 \*\* 299 CFM max with ARP6 reducer plate option.  
 \* Requires Fresh Air Inlet.  
 \* MAX Blower CFM indicates hood blower performance in open air. Find HVI rated performance for this model in the product specification sheet at Broan-NuTone.com  
 † Sones at normal (or working) speed.





EW58



STAINLESS  
30" 36"  
EW5830SS  
EW5836SS

**Inspiring traditional European design.** This wonderful design is executed to meet today's needs so that everyone can achieve their dream.

- Traditional Italian design with high-performance features.
- Available in brushed stainless steel.
- Two widths 30" & 36"; in a 19-3/4" depth.
- Powerful internal 520 MAX Blower CFM.
- Bright dual halogen lighting; 3-intensity settings (35-watt lamps included).
- 3-Speed electronic push button control with blue speed selection indication.
- Control features include Delay-off and Filter clean reminder.
- Optional Remote Control Operation—BCR1.
- Quick release aluminum mesh filters.
- Designed to work with Broan Automatic Make-up air dampers.
- Heat Sentry™ detects excessive heat and adjusts blower speed automatically.
- Telescopic flue accommodates ceiling heights 8' to 9'. Flue extensions for higher ceilings are also available.<sup>1</sup>



Optional BCR1 Remote Control

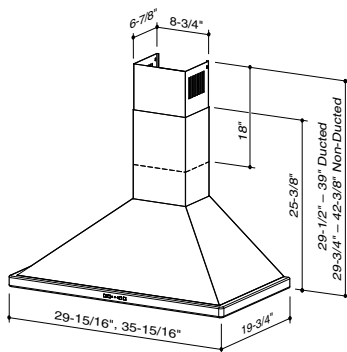

**SPECIFICATIONS**

Width	MAX Blower CFM*	Blower	Sones <sup>†</sup>	Volts	Amps	Duct
29-15/16", 35-15/16"	520	Internal	2.5	120	3.05	6" RD

**OPTIONAL ACCESSORIES**

Flue Extension <sup>1</sup>	FXNE58SS
Non-Ducted Kit**	RKE58
Non-ducted Filter	FILTERE56
Remote Control	BCR1
Make-Up Air Damper	MD6T, MD8T, MD10T

<sup>1</sup> Optional flue extension for either ducted or non-ducted 10' ceilings.  
 \*\* Includes non-ducted filter & flex duct.  
 † 299 CFM max with ARP6 reducer plate option.  
 \* MAX Blower CFM indicates hood blower performance in open air. Find HVI rated performance for this model in the product specification sheet at Broan-NuTone.com  
 † Sones at normal (or working) speed.

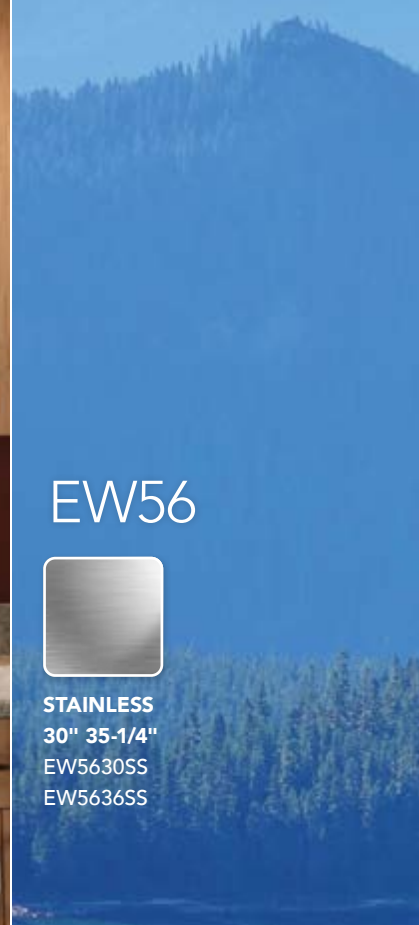

EW56



STAINLESS  
30" 35-1/4"  
EW5630SS  
EW5636SS

**Elegant European curved glass design that is both beautiful and functional.** The airy design is a stunning focal point that complements its surrounding perfectly.

- Contemporary Italian Glass Canopy design.
- Available in brushed stainless steel.
- Two widths 30" & 35-1/4"; in a 19-3/4" depth.
- Powerful internal 650 MAX Blower CFM.
- Bright dual halogen lighting; 3-intensity settings (35-watt lamps included).
- 3-Speed electronic push button control with blue speed selection indication.
- Control features include Delay-off and Filter clean reminder.
- Optional Remote Control Operation—BCR1.
- Quick release aluminum mesh filters.
- Designed to work with Broan Automatic Make-up air dampers.
- Heat Sentry™ detects excessive heat and adjusts blower speed automatically.
- Telescopic flue accommodates ceiling heights 8' to 9'. Flue extensions for higher ceilings are also available.<sup>1</sup>



Optional BCR1 Remote Control

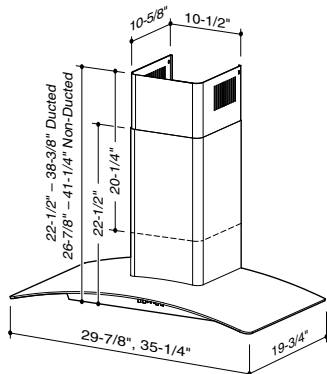

**SPECIFICATIONS**

Width	MAX Blower CFM*	Blower	Sones†	Volts	Amps	Duct
30" 35-1/4"	650	Internal	2.5	120	2.88	6" RD

**OPTIONAL ACCESSORIES**

Flue Extension <sup>1</sup>	FXNE56SS
Non-Ducted Kit**	RKE56
Non-ducted Filter	FILTERE56FL
Remote Control	BCR1
Make-Up Air Damper	MD6T, MD8T, MD10T

<sup>1</sup> Optional flue extension for either ducted or non-ducted 10' ceilings.

\*\* Includes non-ducted filter & flex duct.

† 299 CFM max with ARP6 reducer plate option.

\* MAX Blower CFM indicates hood blower performance in open air. Find HVI rated performance for this model in the product specification sheet at Broan-NuTone.com

† Sones at normal (or working) speed.





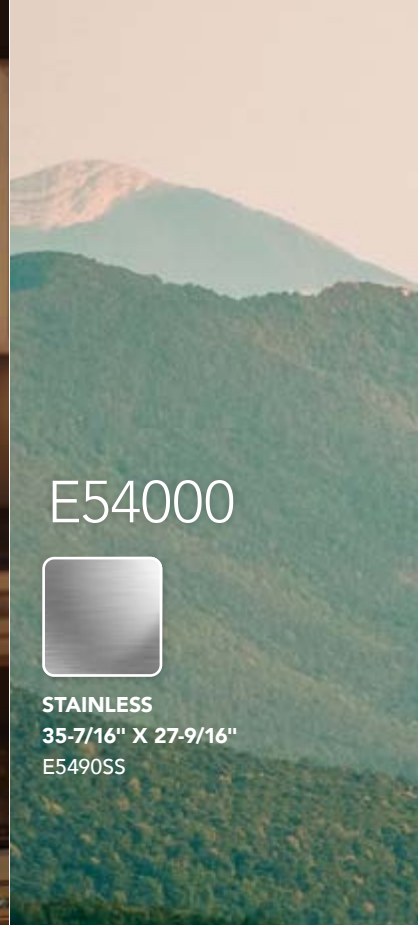

E54000



STAINLESS  
35-7/16" X 27-9/16"  
E5490SS

**Elegant symmetry from every angle.** Graceful curves and a low-profile design make this island hood at home in any décor.

- Brushed stainless steel finish.
- 35-7/16" x 27-9/16" dimension.
- Multi-speed slide control.
- Four 20-watt halogen lamps included (one level).
- Dishwasher-safe aluminum filters.
- Telescopic flue accommodates 8' to 9' ceilings—flue extension available for 10' ducted and non-ducted applications.\*
- Internal blower delivers 550 CFM (<300 CFM with ARP6).
- Non-ducted kit for indoor recirculation (purchase separately).
- Heat Sentry™ detects excessive heat and adjusts blower speed to high automatically.

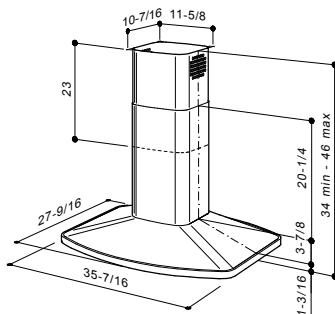

**SPECIFICATIONS**

Width	MAX Blower CFM*	Blower	Sones†	Volts	Amps	Duct
35-7/16"	550	Internal	3.0	120	3.56	6" RD

**OPTIONAL ACCESSORIES**

<b>Flue Extension</b>	FX54SS
<b>Non-ducted</b>	FXN54SS
<b>Non-Ducted Kit<sup>1</sup></b>	RK54
<b>Non-ducted Filter</b>	FILTERSQUARE
<b>Make-Up Air Damper</b>	MD6TU, MD8TU, MD10TU

<sup>1</sup> Includes non-ducted filter.

\*\* 299 CFM max with ARP6 reducer plate option.

\* MAX Blower CFM indicates hood blower performance in open air. Find HVI rated performance for this model in the product specification sheet at Broan-NuTone.com

† Sones at normal (or working) speed.



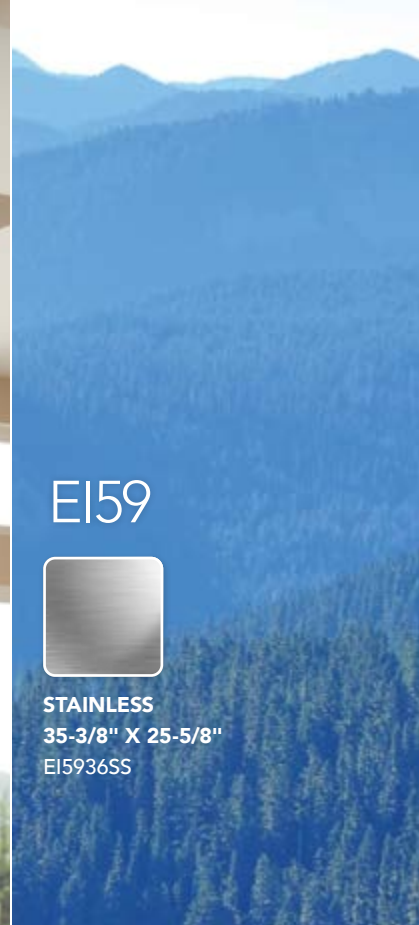

EI59



STAINLESS  
35-3/8" X 25-5/8"  
EI5936SS

**Beautiful contemporary European glass island design.** The curved glass canopy provides a stunning focal point without blocking the view of your surroundings.

- Contemporary Italian Glass Canopy design.
- Available in brushed stainless steel.
- 35-3/8" x 25-5/8" dimension.
- Powerful internal 520 MAX Blower CFM.
- Bright quad halogen lighting; 3-intensity settings (lamps included).
- 3-Speed electronic push button control with blue speed selection indication.
- Control features include Delay-off and Filter clean reminder.
- Optional Remote Control Operation—BCR1.
- Quick release aluminum mesh filters.
- Designed to work with Broan Automatic Make-up air dampers.
- Heat Sentry™ detects excessive heat and adjusts blower speed automatically.
- Telescopic flue accommodates ceiling heights 8' to 9'.



Controls



Optional BCR1 Remote Control

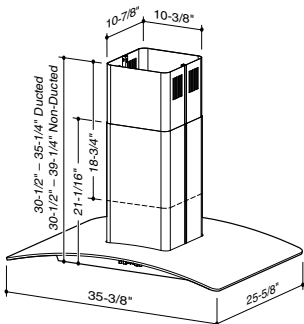

**SPECIFICATIONS**

Width	MAX Blower CFM*	Blower	Sones†	Volts	Amps	Duct
35-3/8"	520	Internal	2.5	120	3.55	6" RD

**OPTIONAL ACCESSORIES**

Flue Extension <sup>1</sup>	FXNE59SS
Non-Ducted Kit**	RKE59
Non-Ducted Filter	FILTERE56
Remote Control	BCR1
Make-Up Air Damper	MD6T, MD8T, MD10T

<sup>1</sup> Optional flue extension for either ducted or non-ducted 9' to 10' ceilings.

† Sones at normal (or working) speed.

\*\* Includes non-ducted filter & flex duct.

\* MAX Blower CFM indicates hood blower performance in open air. Find HVI rated performance for this model in the product specification sheet at Broan-NuTone.com



E64000



E64000 shown with a custom backsplash.

### Professional style that fits under any cabinet.

- Brushed stainless steel finish.
- Bright halogen lighting; Two 50-watt bulbs in 30" and 36" widths, Three 50-watt bulbs in 42" and 48" widths (purchase bulbs separately).
- Pro-style, dishwasher-safe baffle filters with removable grease drip rail.
- Variable speed control remembers last setting—blue LED power-on indicator light.
- Heat Sentry™ detects excessive heat and adjusts blower speed automatically.
- Designed to duct out of the hood shell in either horizontal or vertical direction with internal blowers. External blowers duct vertically.
- Designed to work with Broan Automatic Make-Up Air Damper.
- When venting to the exterior is not possible, an optional non-duct kit will filter air through charcoal filters and recirculate it back into the kitchen.



**STAINLESS  
650 MAX  
Blower CFM**  
30" E6430SS  
36" E6436SS  
42" E6442SS  
48" E6448SS



**EXTERNAL  
BLOWER**  
30" E64E30SS  
36" E64E36SS  
42" E64E42SS  
48" E64E48SS

**1290 MAX  
Blower CFM**  
48" E6448TSS



HIGH PERFORMANCE

**BROAN** *Elite*

# E64000 Specifications & Options

## INTERNAL BLOWER SPECIFICATIONS (See page 74 for External blowers)

Width	MAX Blower CFM*	Blower	Sones†	Lamps	Max Amps*	Ducting <sup>1</sup>
30", 36", 42", 48"	650	Internal	1.5	2-50W GU10	5.5	3-1/4" x 10"
48"	1290		2.0	3-50W GU10	9.0	4-1/2" x 18-1/2"

<sup>1</sup> Duct adapter & damper is included with the Internal blowers.

♦ 120V 60Hz

\* MAX Blower CFM indicates hood blower performance in open air. Find HVI rated performance for this model in the product specification sheet at Broan-NuTone.com

† Sones at normal (or working) speed.

## EXTERNAL BLOWER SPECIFICATIONS

Width	MAX Blower CFM* <sup>1</sup> (See pages 74-75)	Blower	Sones <sup>2</sup>	Lamps	Max Amps*	Ducting <sup>3</sup>
30"	320-1620	External	See below	2-50W GU10	5.5	10" RD
36"				3-50W GU10	6.0	
42"						
48"						

<sup>1</sup> See pages 74-75 for Exterior (660-1620 MAX Blower CFM) and Inline (320-1540 MAX Blower CFM) blower specifications.

<sup>2</sup> Sone levels are typically half of comparable CFM internal blowers.

<sup>3</sup> External blower capable models include the 332KR rough-in kit, purchase blowers separately.

♦ 120V 60Hz

\* MAX Blower CFM indicates hood blower performance in open air. Find HVI rated performance for this model in the product specification sheet at Broan-NuTone.com

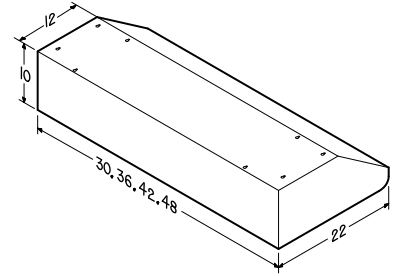

Pro-style, dishwasher-safe baffle filters with removable grease drip rail. Filters feature handles for convenient removal.



Shown with non-duct recirculating kit.

Adapt to any installation.  
Quality Broan Elite options let you create a custom look.

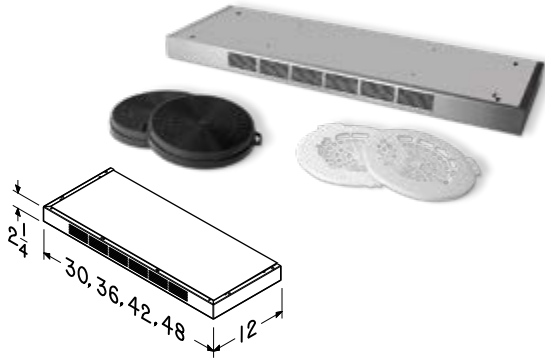

A non-duct kit may be used to recirculate filtered air back into the kitchen if ducting is not practical.

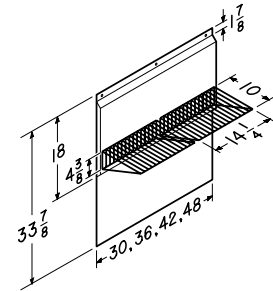

Restaurant-quality stainless steel backsplash with fold-down shelves completes the commercial look and is easy to clean.

## E64000 OPTIONS SELECTION TABLE

Width	Non-Duct Kit†	Backsplash	Non-ducted Filter	Make-up Air Damper
30"	ANKE60302SS*	RMP3004	ROUNDFILTER	MD6T, MD8T, MD10T
36"	ANKE60362SS*	RMP3604		
42"	ANKE60422SS*	RMP4204		
48"***	ANKE60482SS*	RMP4804		

† For models with internal blowers only.

\* Includes non-ducted filters.

\*\* Requires two packs for dual blower models.





# E60000



E60000 shown with optional 12" soffit flue.

## Take professional style to new heights.

- Brushed stainless steel finish.
- Bright halogen lighting; Two 50-watt bulbs in 30" and 36" widths, Three 50-watt bulbs in 42" and 48" widths (purchase bulbs separately).
- Pro-style, dishwasher-safe baffle filters with removable grease drip rail.
- Variable speed control remembers last setting—blue LED power-on indicator light.
- Heat Sentry™ detects excessive heat and adjusts blower speed automatically.
- Designed to duct out of the hood shell in either horizontal or vertical direction with any blower configuration.
- Designed to work with Broan Automatic Make-Up Air Damper.
- When venting to the exterior is not possible, an optional non-duct kit will filter air through charcoal filters and recirculate it back into the kitchen.



**STAINLESS  
650 MAX  
Blower CFM**  
30" E6030SS  
36" E6036SS



**EXTERNAL  
BLOWER**  
30" E60E30SS  
36" E60E36SS  
42" E60E42SS  
48" E60E48SS

**1290 MAX  
Blower CFM**  
42" E6042TSS  
48" E6048TSS





# Pro Outdoor EPD61



EPD61 shown with optional 3" wall extension and 16" flue cover.

**Extra deep design** and improved performance for best-in-class capture.

- Professional outdoor design.
- Deep 27" depth to handle heat and size of outdoor gas grills (optional 3" wall extension).
- Brushed corrosion resistant stainless steel.
- Four widths: 36", 42", 48" and 60".
- Powerful 1290 MAX Blower CFM.
- Bright halogen lighting; two in 36" and 42", three in 48" and 60" models (bulbs not included).
- Three-speed rotary control designed to resist the effects of heat and moisture.
- Stainless steel baffle filters.
- Heat Sentry™ detects excessive heat and adjusts blower speed automatically.
- HVI certified performance.



#### STAINLESS

36" EPD6136SS

42" EPD6142SS

48" EPD6148SS

60" EPD6160SS



HIGH PERFORMANCE

**BROAN** *Elite*



# EPD61 Specifications & Options

## INTERNAL BLOWER SPECIFICATIONS

Width	MAX Blower CFM*	Blower	Sones†	Volts	Max Amps	Duct
36", 42", 48", 60"	1290	Internal	2.0	120	9.0	10" RD

\* MAX Blower CFM indicates hood blower performance in open air. Find HVI rated performance for this model in the product specification sheet at Broan-NuTone.com

† Sones at normal (or working) speed.

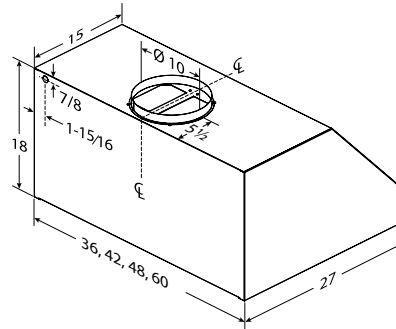

1290 Max CFM Internal Blower tested to assure operation in corrosive environments.

## Accessories

Flue covers are available in corrosion resistant stainless steel and attach to the top of the range hood shell. Flue covers come in 6", 18" and 30" heights. Deeper flue covers are available for hoods using the 3" wall extension.

### FLUE COVER SPECIFICATIONS

Heights	Flue Cover 13" (Standard Depth)	Flue Cover 16" (Extended Depth)
6" for 8' ceiling	AEEP6SS	AEEP6SSE
18" for 9' ceiling	AEEP18SS	AEEP18SSE
30" for 10' ceiling	AEEP30SS	AEEP30SSE

Corrosion resistant stainless steel.

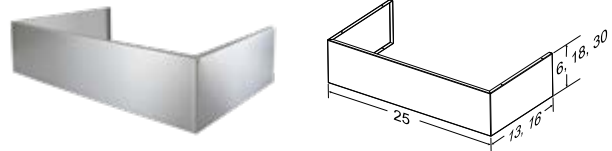

### TELESCOPIC FLUE COVER SPECIFICATIONS

Heights	Flue Cover 13" (Standard Depth)	Flue Cover 16" (Extended Depth)
24"-45" for 9-1/2'-11-1/2' ceiling	AEEP2445SS	AEEP2445SSE

Corrosion resistant stainless steel.

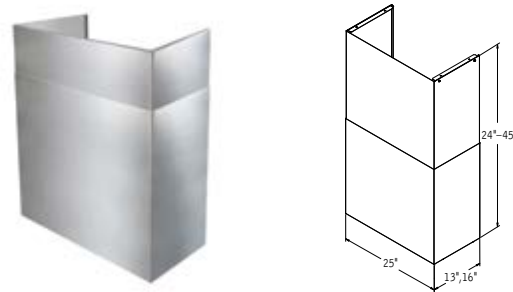

### 3" WALL EXTENSION

Width	Model
36"	AWEPD36SS
42"	AWEPD42SS
48"	AWEPD48SS
60"	AWEPD60SS

Optional 3" wall extension extends hood depth to 30" for even greater coverage; expensive custom wall bump-out is eliminated.

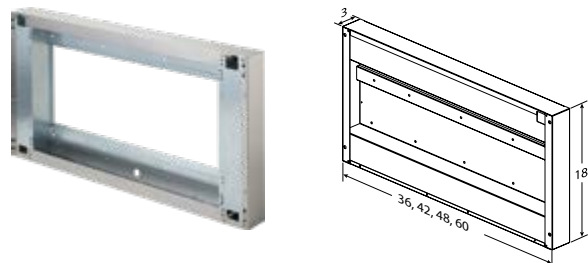



Shown: PM390 in custom  
cabinetry on page 32

# Built-in

There when needed—hidden when not. Enjoy powerful ventilation at the touch of a button. Add a downdraft to an island installation—raise it when cooking, lower it when entertaining. Hide a power pack insert in custom cabinetry for a completely hidden solution. You have a vision. Broan will help you see it through.



# PM390SSP



**STAINLESS**  
20-1/2"  
PM390SSP

Shown with optional LB30SS liner

**This three-speed power pack insert delivers up to 440 CFM.** The quick-release filter is dishwasher safe, and smooth surfaces clean easily. Achieve a custom look and protect cabinetry with stainless steel liners.

- 440 MAX Blower CFM, 2.5 sones at normal speed.
- Three-speed, push-button control includes a dedicated on/off.
- Bright LED strip-lighting modules illuminate evenly and are tested in cooking environments to ensure long life without dimming.
- Heat Sentry™ detects excessive heat and adjusts blower speed to high automatically.
- 6" round duct adapter with damper.
- Easy-to-clean, fully enclosed bottom with dishwasher-safe, aluminum-mesh filter.
- Optional non-duct operation using 360NDK non-duct kit and charcoal filter, sold separately.
- Works with optional Universal Make-up Air Dampers.
- Works with optional stainless LB liners and painted LT liners.

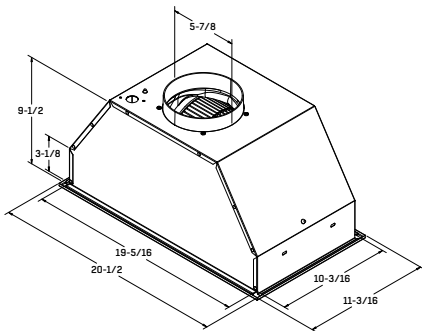
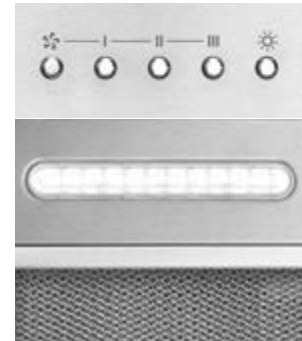

### SPECIFICATIONS

Width	MAX Blower CFM*	Blower	Sones†	Volts	Amps	Duct
20-1/2"	440	Internal	2.5	120	2.3	6" RD

\* MAX Blower CFM indicates hood blower performance in open air. Find HVI rated performance for this model in the product specification sheet at Broan-NuTone.com

† Sones at normal (or working) speed.

### OPTIONAL ACCESSORIES

Non-Duct Kit	Non-Duct Charcoal Filter	Replacement Aluminum Filter	LED	Make-Up Air Dampers	Fresh Air Inlets	Liners
360NDK	S99010464	S99010400	Included	MD6TU MD8TU MD10TU	641FA 643FA 610FA	LB30SS LB36SS LT30 LT36







# PM250SSP



**STAINLESS**  
20-1/2"  
PM250SSP

**This dual-speed power pack insert delivers 300 MAX Blower CFM in a compact size.** Smooth surfaces clean easily, and quick-release filters are dishwasher safe. Get a custom appearance while protecting cabinetry with stainless steel liners.

- 300 MAX Blower CFM, 8.0 sones at high speed.
- Two-speed rocker controls.
- Bright LED strip-lighting modules illuminate evenly and are tested in cooking environments to ensure long life without dimming.
- 7" round duct adapter.
- Easy-to-clean, fully enclosed bottom with dishwasher-safe, aluminum-mesh filter.
- Optional non-duct operation using 358NDK non-duct kit and charcoal filter, sold separately.
- Works with optional Universal Make-up Air Dampers.
- Works with optional stainless LB liners and painted LT liners.

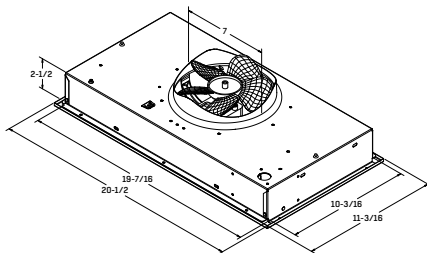

### SPECIFICATIONS

Width	MAX Blower CFM*	Blower	Sones	Volts	Amps	Duct
20-1/2"	300	Internal	8.0	120	1.1	7" RD

\* MAX Blower CFM indicates hood blower performance in open air. Find HVI rated performance for this model in the product specification sheet at [Broan-NuTone.com](http://Broan-NuTone.com)

### OPTIONAL ACCESSORIES

Non-Duct Kit	Non-Duct Charcoal Filter	Replacement Aluminum Filter	LED	Make-Up Air Dampers	Fresh Air Inlets	Liners	Backdraft Damper
358NDK	S99010464	S99010400	Included	MD6TU MD8TU MD10TU	641FA 643FA 610FA	LB30SS LB36SS LT30 LT36	BP87Q



# PM390/PM250



Power Pack Inserts and Modules are completely concealed in custom cabinetry.



**High-performance ventilation solutions.** These power pack inserts provide the ventilation and lighting you need for your custom application.

## Model PM390

- Silver paint finish.
- Three speed, slide control.
- Heat Sentry™ detects excessive heat and adjusts speed automatically.
- Quiet centrifugal blower, 440 MAX Blower CFM (vertical discharge) (<300 CFM with ARP6).
- Dual 40-watt lamps (purchase separately).
- Dishwasher safe aluminum filter.
- For ducted installations, includes adapter and damper for 6" round duct.
- Optional non-ducted filter kit (purchase 357NDK separately).
- Works with optional custom hood liners in 30", 36", "Box" or "T" design.
- ENERGY STAR® version on page 43.

## Model PM250

- Silver paint finish.
- Two speed motor, rocker control.
- Efficient 300 MAX Blower CFM fan (vertical discharge).
- Dual 40-watt lighting (purchase lamps separately).
- Dishwasher safe aluminum filter.
- For ducted installations, built-in adapter for 7" round duct.
- Optional non-ducted filter kit (purchase 356NDK separately).
- Works with optional custom hood liners in 30", 36", "Box" or "T" design.



**SILVER**  
**20-1/2" PM390**  
**20-1/2" PM250**



# PM390/PM250 Specifications & Options

## SPECIFICATIONS

Width	MAX Blower CFM**	Sones	Blower	Volts	Amps	Duct	OPTIONAL ACCESSORIES					
							Non-ducted Kit†	Aluminum Filter	Charcoal Filter	30" Liners	36" Liners	Make-up Air Damper
20-1/2"	440*	6.5	Internal	120	2.9	6" RD	357NDK	99010370	B08999040	LT30 or LB30	LT36 or LB36	MD6TU, MD8TU, MD10TU
	300	8.0			2.1	7" RD	356NDK					

† Includes charcoal filter. Some duct work is required for non-ducted applications.

\* 299 CFM max with ARP310 reducer plate option.

\*\* MAX Blower CFM indicates hood blower performance in open air. Find HVI rated performance for this model in the product specification sheet at Broan-NuTone.com

## Model PM390

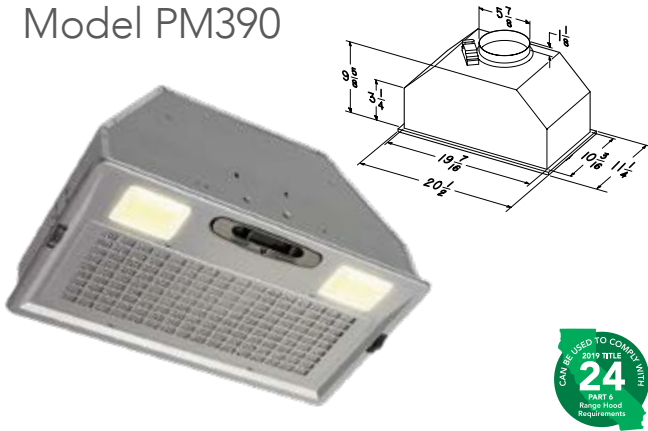

## Model PM250

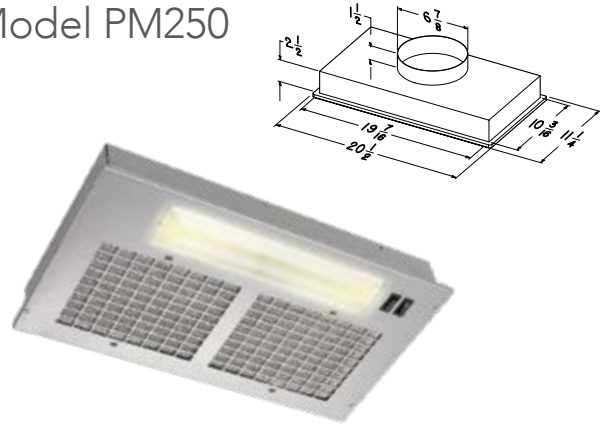

## PM390 & PM250 Liners

Broan "T" and "B" liners provide an elegant way to finish a traditional wood hood and protect cabinetry. They feature a durable silver painted finish and a 4" depth for good capture. Hemmed edges hide exposed edges, and pre-drilled mounting holes make installation easy.

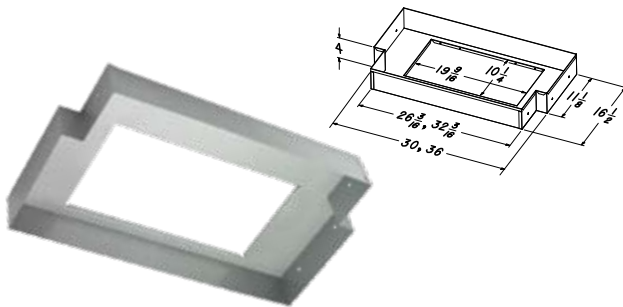

LT30 & 36 "T" liners work with wood hoods that are integrated with adjacent 12" deep cabinets.

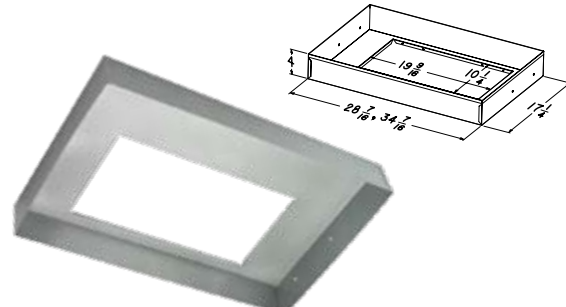

LB30 & 36 "B" (box) liners fit into 18" deep wood hoods or cabinet bottoms.

## Non-duct Kits

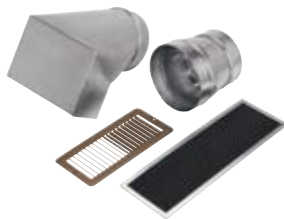

Model 357NDK



Model 356NDK

Depending on your installation of the non-duct system, you may need additional duct or duct components (e.g., elbows).



## 15000 Silhouette



**BRUSHED ALUMINUM**

**30" 36"**

153004

153604

**Slides out of sight when not in use.** This slimline design merges perfectly with the style of any kitchen. The unseen advantages include quiet, powerful ventilation performance.

- Compact, trim styling complements any kitchen.
- Fan and light automatically turn on when you slide out the clear glass visor; shut off when pushed in.
- Energy-efficient, 24" fluorescent light with prismatic glass lens provides bright, even cooktop lighting (bulb not included).
- Dual centrifugal blower, 490 MAX Blower CFM at a quiet 4.5 sones at high speed.
- Infinitely adjustable blower control conveniently located up front; features blower memory—when activated, unit automatically “remembers” the last setting you selected.
- Heat Sentry™ detects excessive heat and adjusts blower speed to high automatically.
- Includes 3-1/4" x 10" duct adapter with built-in damper.

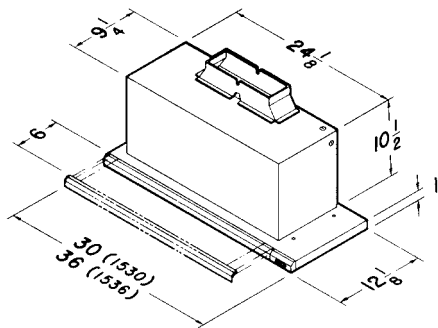

### SPECIFICATIONS

Width	MAX Blower CFM**	Blower	Sones	Volts	Amps	Duct	Bulb*
30", 36"	490†	Internal	4.5	120	3.7	3-1/4" x 10" (vert.)	F20T12

\* Bulb not included.

† 299 CFM max with ARP310 reducer plate option.

\*\* MAX Blower CFM indicates hood blower performance in open air. Find HVI rated performance for this model in the product specification sheet at [Broan-NuTone.com](http://Broan-NuTone.com)



# PM500SS



**STAINLESS**  
20-1/2"  
PM500SS

**The PM500SS delivers the features you expect and the power you need.** Serious cooks will appreciate the full surface coverage of the halogen lighting. Smooth surfaces and quick-release filters clean easily.

- 550 MAX Blower CFM, 9.0 sones at high speed.
- Three-speed, push-button control includes a dedicated on/off.
- Dual halogen bulbs with single light level for bright cooktop lighting (Type JC, 12V, 20W, G4 base), included.
- 6" round duct.
- Easy-to-clean, fully enclosed bottom with dishwasher-safe, aluminum-mesh filters.
- Optional non-duct operation using 359NDK non-duct kit and charcoal filter, sold separately.
- Works with optional Universal Make-up Air Dampers.
- Works with optional LT and LB liners.

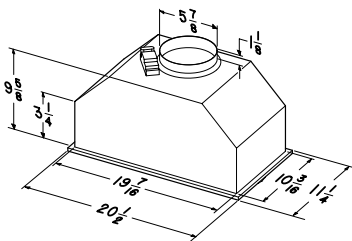

### SPECIFICATIONS

Width	MAX Blower CFM*	Blower	Sones	Volts	Amps	Duct
20-1/2"	550	Internal	9.0	120	2.8	6" RD

\* MAX Blower CFM indicates hood blower performance in open air. Find HVI rated performance for this model in the product specification sheet at Broan-NuTone.com

### OPTIONAL ACCESSORIES

Non-Duct Kit	Non-Duct Charcoal Filter	Aluminum Filter	Halogen Bulb	Fresh Air Inlets	30" Painted Liners	36" Painted Liners	30" Stainless Steel Liners	Make-up Air Dampers
359NDK	SB08999053	B08087039	Type JC 12V 20W G4	641FA, 643FA, 610FA	LT30 or LB30	LT36 or LB36	RML5230S, RML5236S, RML5236L	MD6TU, MD8TU, MD10TU

\* MAX Blower CFM indicates hood blower performance in open air. Find HVI rated performance for this model in the product specification sheet at Broan-NuTone.com







Shown with optional baffle filters. Liner is 4" in depth.

**The Broan Elite RMIP Pro-Style Power Pack Insert fits flush with the bottom of the cabinet or custom hoods.** Centrifugal blower options from 530 to 1650 MAX Blower CFM with multi-speed control provide quiet and effective performance. Halogen lighting complements the beauty of its fully-enclosed, easy-to-clean bottom.

- Brushed stainless steel finish.
- Design allows use with custom liners or Broan Elite Pro-Style Insert liners (sold separately).
- Pro-Style Insert available in 33" and 45" widths.
- Variable speed control for quiet operation.
- Optional remote wall control available.
- Heat Sentry™ detects excessive heat and adjusts blower speed to high automatically.
- Dishwasher-safe stainless steel/ aluminum filters, or optional baffle filters.
- Bright halogen lighting, two 50-watt lamps (RMIP33) or three 50-watt lamps (RMIP45), bulbs not included.
- Choose 530 or 930 MAX Blower CFM Internal, or choice of eight External blower options: four Exterior: 660, 880, 1280, or 1620 MAX Blower CFM, or four In-Line: 320, 670, 890 or 1540 MAX Blower CFM. All blowers sold separately.
- Optional liners in 36", 42", 48" and 60" widths protect custom hoods.



**430 STAINLESS**  
**33-3/4"**  
 RMIP33  
**45-3/4"**  
 RMIP45



RMIPWPC Optional Wall Control.

# RMIP Specifications

## SPECIFICATIONS\*

Width	MAX Blower CFM**	Blower*	Sones†	Amps	OPTIONAL ACCESSORIES		
					Internal Baffle Filter Kit	Wall Control	Make-up Air Damper
33-3/4"	530 (P5), 930 (P8) *	Internal	0.8 (P5)	3.5	RBFIP33	RMIPWC	MD6TU, MD8TU, MD10TU
		External	—				
45-3/4"	530 (P5), 930 (P8) *	Internal	0.8 (P5)		RBFIP45		
		External	—				

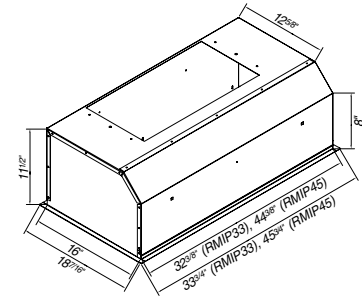

\* All blowers must be purchased separately and are HVI Certified.

See blower specifications table on pages 74–75.

▲ All ratings for vertical duct only.

\*\* MAX Blower CFM indicates hood blower performance in open air. Find HVI rated performance for this model in the product specification sheet at Broan-NuTone.com

† Sones at normal (or working) speed.

## Liners for RMIP Pro-Style Insert

Broan Elite Liners provide a beautiful way to finish your custom hood and protect your cabinetry. Designed to work with Broan Elite Pro-Style Power Pack Insert and Power Pack Inserts, liners feature a 3" adjustable nose to provide application flexibility, and a 4" depth for excellent capture.

- Brushed stainless steel finish.
- Liners are available for 36", 42", 48" and 60" widths.
- Liners allow depth adjustment from 22-1/2" to 25-1/2". Fits stock 24" cabinets.
- Liners are based on the outside width of the custom hood.
- All models compliant with CA Title 24.

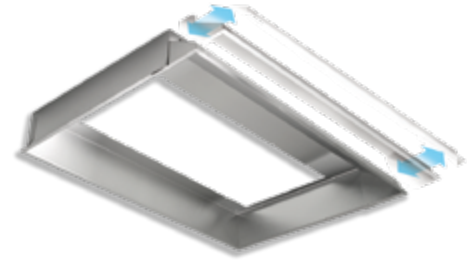

## 3-Step Insert and Blower Selection Guide

### 1. Select the right size Pro-Style Insert

- **RMIP33** (33" width) or **RMIP45** (45" width)
- Both feature an 18-7/16" depth
- 530 or 930 MAX Blower CFM Internal blower options
- 320–1500 MAX Blower CFM External blower options

### 2. Select a Liner to fit your Cabinetry

For cabinet/hood inside depths of 23"–26" choose:

- **RML3336S** 36" width, use with **RMIP33**
- **RML3342S** 42" width, use with **RMIP33**
- **RML4548S** 48" width, use with **RMIP45**
- **RML4560S** 60" width, use with **RMIP45**

### 3. Select a blower for your Insert

Internal blowers:

- **P5** (530 MAX Blower CFM)
- **P8** (930 MAX Blower CFM)

Exterior blowers (outside, roof or wall):

- **331H** (660 MAX Blower CFM)\*
- **332H** (880 MAX Blower CFM)\*
- **335** (1280 MAX Blower CFM)\*
- **336** (1620 MAX Blower CFM)\*

In-Line blowers (inside, attic or other space):

- **HLB3** (320 MAX Blower CFM)
- **HLB6** (670 MAX Blower CFM)\*
- **HLB9** (890 MAX Blower CFM)\*
- **HLB11** (1540 MAX Blower CFM)\*

\* 332KR Rough-In Kit is required when used with Exterior and In-Line blower options above (purchased separately).

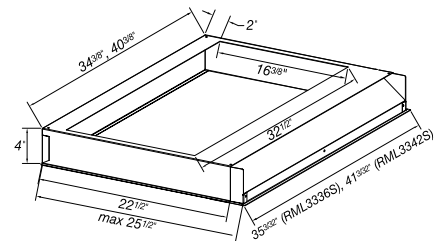

**RML3336S/RML3342S For RMIP33**

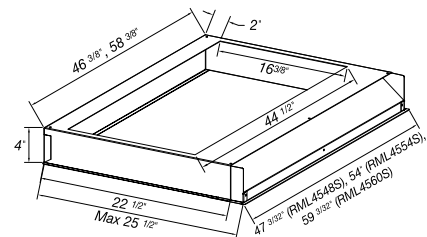

**RML4548S/RML4560S For RMIP45**

# RMP1/RMPE Custom Power Pack Insert



RMP1 shown concealed in custom cabinetry.

Liner is 4" in depth

**The Broan Elite Custom Power Pack Insert is designed to fit flush** with the bottom of a cabinet or custom hood that's 30" to 48" wide. The 400 CFM centrifugal blower is combined with a multi-speed control to provide quiet, effective performance. Halogen lighting complements the beauty of a fully enclosed bottom containing dishwasher-safe filters.

- Three-speed control.
- Heat Sentry™ detects excessive heat and adjusts blower speed to high automatically.
- Internal 550 MAX Blower CFM (<300 CFM with ARP6).
- External blower model (RMPE) allows a choice of eight blower options: four Exterior: 600, 900, 1200 or 1500 CFM, or four In-Line: 280, 600, 800 or 1100 CFM.
- Two 50-watt halogen lamps included (one level).
- Dishwasher-safe aluminum filters feature a quick-release latch and professional-style appearance.
- Optional non-ducted filters (FILTEREB40) for indoor exhaust recirculation, some ductwork required (RMP17004 only).
- Install power pack so that the bottom of the unit is 24" to 30" above the cooking surface.
- Optional custom hood liners in 30", 36" and 48" widths.



**STAINLESS  
INTERNAL BLOWER**  
27-9/16" RMP17004

**EXTERNAL BLOWER**  
27-9/16" RMPE7004



# RMP1/RMPE Specifications

## SPECIFICATIONS

Width	MAX Blower CFM*	Blower	Sones	Volts	Amps	Duct	OPTIONAL ACCESSORIES	
							Non-ducted Filter	Make-up Air Damper
27-9/16"	400	Internal	9	120	3.5	6" RD	FILTEREB40	MD6TU, MD8TU, MD10TU
	†	External†	—			8" RD		

† External blowers sold separately.

\* All blowers are HVI Certified.

Some ductwork required for RMP1 non-ducted installations.

+ 299 CFM max with ARP6 reducer plate option.

\* MAX Blower CFM indicates hood blower performance in open air. Find HVI rated performance for this model in the product specification sheet at Broan-NuTone.com

### RMPE

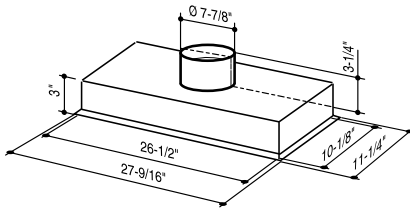

### RMP1

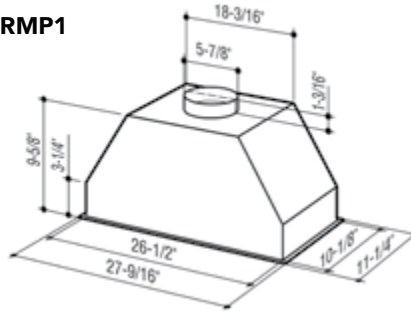

### CUTOUT

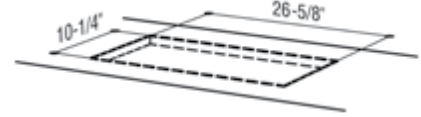

## Liners for RMP1/RMPE Power Pack Insert

Broan Elite Liners provide a beautiful way to finish your custom hood and protect your cabinetry. Designed to work with Broan Elite Pro-Insert and Power Packs, liners feature a 3" adjustable nose to provide application flexibility, and a 4" depth for excellent capture.

- Brushed stainless steel finish.
- Liners protect custom hoods and are available for 30", 36" and 48" widths.
- Two versions for maximum flexibility in depth adjustment:  
"S" version adjusts 17-1/8"–20-1/8".  
"L" version adjusts 20-1/8"–23-1/8".
- Liners are based on the outside width of the custom hood.

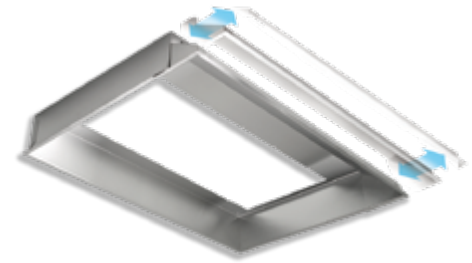

## 3-Step Power Pack Insert and Blower Guide

### 1. Select a Power Pack system

**RMP17004**, 400 CFM Internal blower

- 27-9/16" width, 11-1/4" depth

**RMPE7004**, 320–1620 MAX Blower CFM External blower options

- 27-9/16" width, 11-1/4" depth

### 2. Select a Liner to fit your Cabinetry

If the cabinet/hood inside depth is 18"–21", choose model:

- **RML7030S** for 30" width
- **RML7036S** for 36" width
- **RML7048S** for 48" width

If the cabinet/hood inside depth is 21"–24", choose model:

- **RML7030L** for 30" width
- **RML7036L** for 36" width
- **RML7048L** for 48" width

### 3. Select an Internal or External Blower

**RMP17004**,

Internal 400 CFM blower is included

**RMPE7004**,

External blower options (choose one):

Exterior blowers (outside, roof or wall):

- **331H** (660 MAX Blower CFM)\*
- **332H** (880 MAX Blower CFM)\*
- **335** (1280 MAX Blower CFM)\*
- **336** (1620 MAX Blower CFM)\*

In-Line blowers (inside, attic or other space):

- **HLB3** (320 MAX Blower CFM)
- **HLB6** (670 MAX Blower CFM)\*
- **HLB9** (890 MAX Blower CFM)\*
- **HLB11** (1540 MAX Blower CFM)\*

\* 8"–10" transition (model 414) is required for the Exterior or In-Line models.

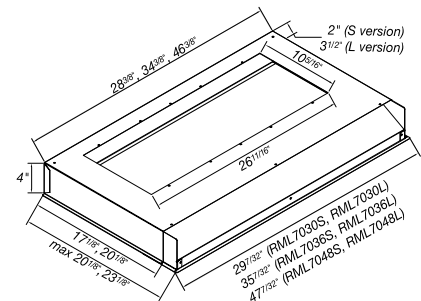

**RML7030S/RML7030L**

**RML7036S/RML7036L**

**RML7048S/RML7048L**

**For RMP17004 and RMPE7004 Packs**



## RMDD Downdraft



**STAINLESS  
INTERNAL**  
30" 36" 48"  
RMDD3004  
RMDD3604  
RMDD4804



**STAINLESS  
EXTERNAL**  
30" 36"  
RMDD3004EX  
RMDD3604EX

**Ready where and when you need it.** Rises to new heights to meet the needs of high-end commercial style cooking.

- Compact design is installed directly behind the cooktop for an unobtrusive appearance. Thin profile saves precious space under the cabinet.
- Chimney rises over 9-1/2" when activated, ideal for large pots and pans.
- Infinitely adjustable control is designed to provide convenient access to govern the blower speed for effective and quiet operation.
- Optional remote control will activate downdraft from an alternate location.
- Heat Sentry™ detects excessive heat and adjusts blower speed to high automatically.
- Dishwasher-safe filters are easy to remove and feature a stylish brushed stainless steel appearance for a professional look.
- These units are not for installations behind ovens.
- 600 MAX Blower CFM centrifugal blower or choice of eight External blower options: four Exterior blowers from 660 to 1540 MAX Blower CFM, or four In-Line blowers from 660 to 1620 MAX Blower CFM. See pages 74–75.
- Unique ducting capability allows the internal or remote blower connection to be ducted to the left, right or downward.



Install the hood so that the bottom of the unit is 24" to 30" above the cooking surface. Mounting height may be affected by ceiling height.

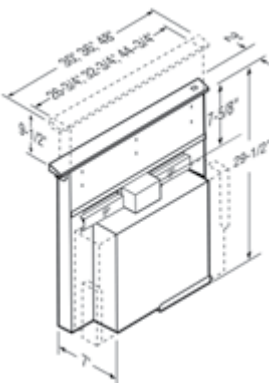

### SPECIFICATIONS

Width	Blower	MAX Blower CFM*	Sones	Volts	Amps	Duct	OPTIONAL ACCESSORIES	
							Remote Button Kit	Make-Up Air Damper
30", 36", 48"	Internal	600**	—	120	4	3-1/4" x 10"	RMDDRBK	MD6TU, MD8TU, MD10TU
	External†	—			6			

† External and In-Line blowers sold separately.

\* MAX Blower CFM indicates hood blower performance in open air. Find HVI rated performance for this model in the product specification sheet at Broan-NuTone.com

\*\* 299 CFM max with ARP310 reducer plate option.

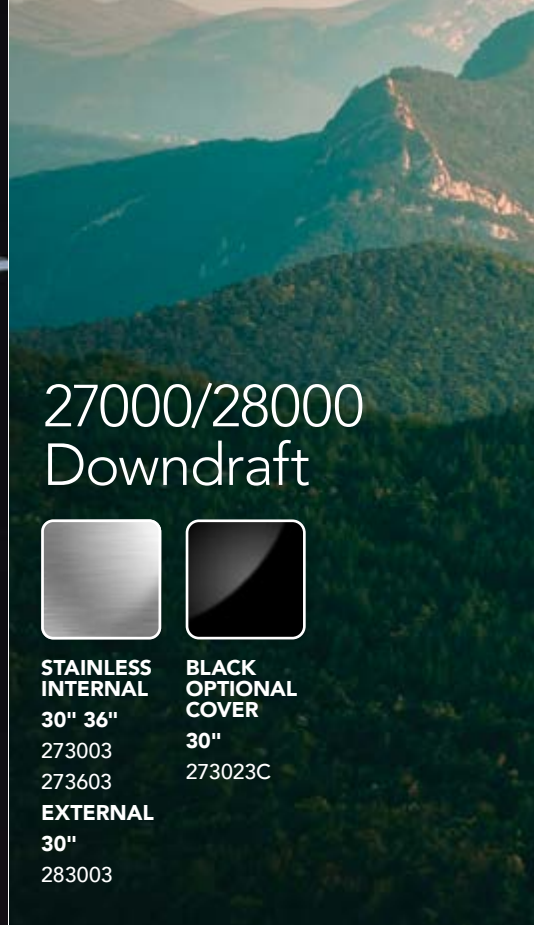

## 27000/28000 Downdraft



**STAINLESS  
INTERNAL**

**30" 36"**

273003

273603

**EXTERNAL**

**30"**

283003



**BLACK  
OPTIONAL  
COVER**

**30"**

273023C

**Convenient options help assure a custom fit.** For the unique demands of cooktops in islands and peninsulas.

- Innovative downdraft system is compatible with virtually all self-contained cooktops.
- Sleek, trim styling complements any cooktop style or color.
- Automatically rises 7" with the touch of a button. Disappears flush with cooktop surface.
- Space-saving design lets you make the most of precious, under-counter cabinet space.
- Infinitely adjustable speed control is flush with the side of the unit; inconspicuous, yet easy to reach and simple to use.
- Model 27000 Blower discharges right, left or down and slides side-to-side to ease installation.
- These units are not for installations behind ovens.
- Stainless Steel cover standard. White or Black optional.

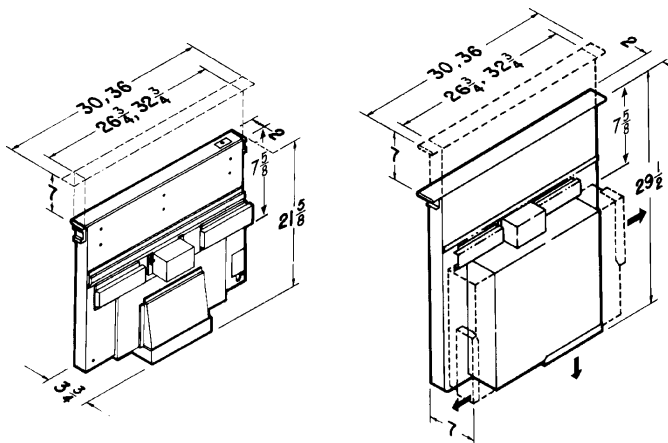

**Model 28000**  
Use with 880 MAX Blower CFM  
Exterior blower (Model 332H) or  
In-Line blower.

**Model 27000**  
Includes 600 MAX Blower CFM Internal  
blower (<300 CFM with ARP310).

### SPECIFICATIONS

Width	MAX Blower CFM <sup>1</sup>	Blower	Volts	Amps	Duct
30", 36"	600 <sup>+</sup>	Internal	120	4	3-1/4" x 10"
	*	External		6.0 max	3-1/4" x 10" <sup>†</sup>

<sup>1</sup> MAX Blower CFM indicates hood blower performance in open air. Find HVI rated performance for this model in the product specification sheet at [Broan-NuTone.com](http://Broan-NuTone.com)

<sup>+</sup> 299 CFM max with ARP310 reducer plate option.

\* External unit utilizes model 332H Exterior-mounted blower. In-Line blower sold separately.

\*\* Cooktops, countertops and cabinets vary in dimension and support systems depending upon manufacturer. These factors may impact the ability to fit with every worktop/cabinet combination. Specifications subject to change without notice.

<sup>†</sup> Model 28000 requires transitioning from 3-1/4" x 10" to 10" round for connection to the External blower.





Shown: BCSEK130BL on page 46

# ENERGY STAR®



Broan makes it easy to go green with a variety of ENERGY STAR® certified range hoods. With efficient motor designs as well as LED and compact fluorescent lighting options, these range hoods meet the program requirements of USGBC®, LEED® and NAHB.



PME300



SILVER  
20-1/2"  
PME300

**ENERGY STAR® efficiency**, for custom applications provides the ventilation and lighting you need in one integrated package.

- Silver paint finish.
- Three speed, slide control.
- Heat Sentry™ detects excessive heat and adjusts speed automatically.
- Quiet centrifugal blower, 350 MAX Blower CFM (vertical discharge).
- 0.5 Sones at normal speed (130 CFM).
- Dual 13-watt fluorescent lamps included.
- Dishwasher safe aluminum filter.
- For ducted installations, includes adapter and damper for 6" round duct.
- Works with optional custom hood liners in 30", 36", "Box" or "T" design.

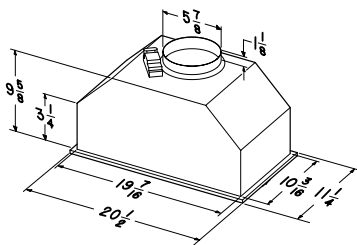

**SPECIFICATIONS**

SPECIFICATIONS							OPTIONAL ACCESSORIES		
Width	MAX Blower CFM*	Blower	Sones†	Volts	Amps	Duct	Aluminum Filter	30" Liners	36" Liners
20-1/2"	350	Internal	0.5	120	2.9	6" RD	B08087694	LT30 or LB30	LT36 or LB36

\* MAX Blower CFM indicates hood blower performance in open air. Find HVI rated performance for this model in the product specification sheet at Broan-NuTone.com  
 † Sones at normal (or working) speed.





SPE1



STAINLESS  
30" 36"  
SPE130SS  
SPE136SS

**Broan Elite brings you Spire**, an exciting new shape in a pro-style hood. Its high efficiency ensures energy savings while you enjoy pro-style performance.

- The Captur™ system's advanced blower design features a forward positioned centric inlet to remove smoke and odor faster. Three-speed blower control exhausts at a powerful 650 MAX Blower CFM.
- Forward placement and smooth-flow blower wheel design ensure quiet, <0.3 sone operation at normal speed.
- Bright, two-level LED modules—supported by a 3-year warranty—illuminate evenly and are tested in cooking environments to ensure long life without dimming. ENERGY STAR® qualified LEDs maximize savings.
- Tap-touch, 3-speed capacitive control features a smooth, easy-to-clean surface.
- Dishwasher-safe, hybrid baffle filters provide ultra-efficient grease removal with superior air flow. The filter clean reminder ensures they will always maintain a high level of capture.
- EZ1 brackets enable single-person installation in less than half the time of traditional methods.
- ADA compliant, remote operation is possible using a standard UL approved wall switch (kit sold separately).
- Non-duct capable with use of charcoal filters, sold separately. Hidden louvers on top of hood exhaust away from cabinetry.
- Non-duct installation does not meet ENERGY STAR® requirements.



**Captur™**

For faster smoke and odor removal.

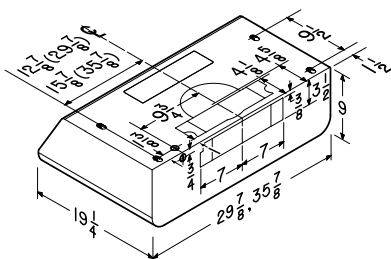

**SPECIFICATIONS**

Width	MAX Blower CFM	Sones†	Volts	Amps	Duct
30"	650	<0.3	120	1.9	3-1/4" x 14" or 7" RD
36"					Optional 3-1/4" x 10"

**OPTIONAL ACCESSORIES**

Non-Ducted Charcoal Filter	ADA Electronic Adapter Kit*	Make-Up Air Dampers
HPF24 (Type Xb)	HAWRK3	MD6TU, MD8TU, MD10TU
HPF30 (Type Xc)		

\* Kit sold separately.  
† Sones at normal (or working) speed.





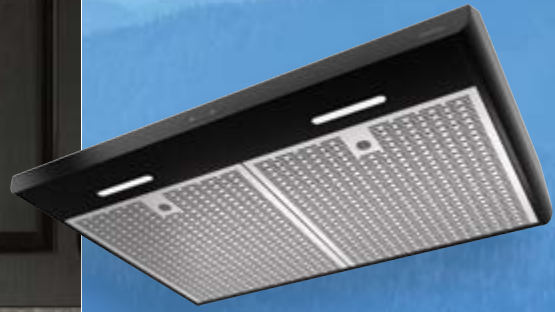

## BKDEG1



**STAINLESS**  
30"  
BKDEG130SS



**BLACK**  
30"  
BKDEG130BL

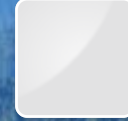

**WHITE**  
30"  
BKDEG130WW

**The slim and refined lines of Sahale bring a refreshing change to today's kitchens.** Bright ENERGY STAR® certified LED lighting complements your cooking experience and three fan speeds make cooking more enjoyable.

- The Captur™ system's advanced blower design features a forward positioned centric inlet to remove smoke and odor faster. A smooth-flow blower wheel and high flow filters ensure quiet operation.
- 375 MAX Blower CFM operates at 1.5 sones at normal speed; as low as 1.2 sones in some duct configurations
- Bright, two-level LED modules—supported by a 3-year warranty—illuminate evenly and are tested in cooking environments to ensure long life without dimming. ENERGY STAR® certification saves energy expense.
- Tap-touch, three-speed capacitive control features a smooth, easy-to-clean surface.
- Dishwasher-safe, deluxe micro-mesh filters provide highly efficient grease removal and patterned cover provides a decorative design. The filter clean reminder ensures a high level of capture.
- EZ1 brackets make it easy for single-person installation in less than half the time of traditional methods.
- ADA compliant, remote operation is possible using a standard UL approved wall switch. Requires ADA Adapter Kit.
- Non-duct capable with use of charcoal filters, sold separately. Hidden louvers on top of hood exhaust away from cabinetry.
- Non-duct installation does not meet ENERGY STAR® requirements.



### Captur™

For faster smoke and odor removal.

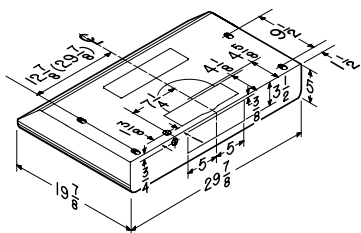

#### SPECIFICATIONS

Width	MAX Blower CFM*	Blower	Sones†	Volts	Amps	Duct
30"	375	Internal	1.2	120	.65	3-1/4 x 10" (V, H) 7" RD

#### OPTIONAL ACCESSORIES

Non-ducted Charcoal Filter	ADA Electronic Adapter Kit
HPF30 (Type Xc)	HAWRK3

\* MAX Blower CFM indicates hood blower performance in open air. Find HVI rated performance for this model in the product specification sheet at Broan-NuTone.com  
 † Sones at normal (or working) speed.



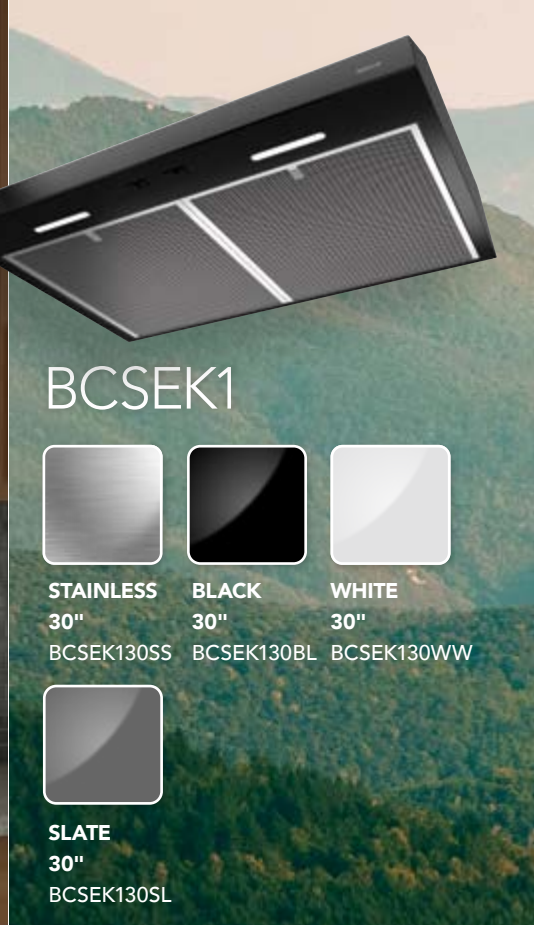

## BCSEK1



STAINLESS

30"

BCSEK130SS



BLACK

30"

BCSEK130BL

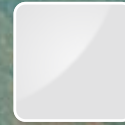

WHITE

30"

BCSEK130WW



SLATE

30"

BCSEK130SL

The clean, contemporary shape of Glacier complements any kitchen design. Impressive ENERGY STAR® certified LED lighting and superior smoke and odor removal are a mere introduction to everything this hood has to offer.

- The Captur™ system's advanced blower design features a forward positioned centric inlet to remove smoke and odor faster. A smooth-flow blower wheel and high flow filters ensure quiet operation.
- 300 MAX Blower CFM operates at 1.5 sones at normal speed.
- Bright, single intensity LED modules—supported by a 3-year warranty—illuminate evenly and are tested in cooking environments to ensure long life without dimming. ENERGY STAR® certification saves energy expense.
- Hidden two-speed on/off rocker switch.
- Dual dishwasher-safe, open-mesh filters provide efficient grease removal.
- EZ1 brackets make it easy for single-person installation in less than half the time of traditional methods.
- ADA compliant, remote operation is possible using a standard UL approved wall switch.
- Non-duct capable with use of charcoal filters, sold separately. Hidden louvers on top of hood exhaust away from cabinetry.
- Non-duct installation does not meet ENERGY STAR® requirements.

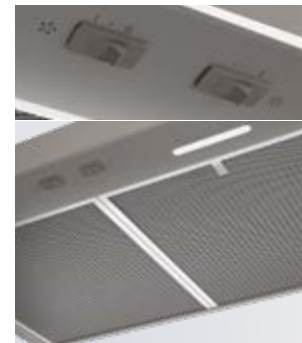

### Captur™

For faster smoke and odor removal.

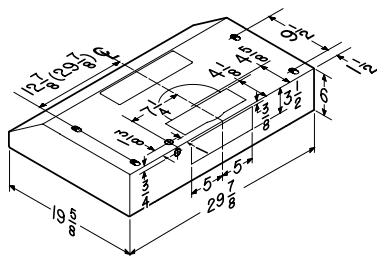

#### SPECIFICATIONS

Width	MAX Blower CFM*	Blower	Sones†	Volts	Amps	Duct
30"	300	Internal	1.5	120	.65	3-1/4 x 10" (V, H) 7" RD (V only)

† Sones at normal (or working) speed.

#### OPTIONAL ACCESSORIES

Non-ducted Charcoal Filter
HPF30 (Type Xc)









Shown: BCDF1 on page 57

# Under Cabinets

Every kitchen needs adequate ventilation matched to your cooking style, and your unique sense of style. That's why Broan redesigned nearly every hood in our popular under cabinet category. For style, LED lighting, control options and more—start here.







## ALTA3



**STAINLESS**  
**30" 36"**  
 ALT330SS  
 ALT336SS

The sculpted lines of Alta® bring an exciting, new choice to typical range hood shapes. Sophisticated curves, infrared controls and hybrid baffle filters lend a pro-style edge to your kitchen.

- The Captur™ system's advanced blower design features a forward positioned centric inlet to remove smoke and odor faster. Three-speed blower control exhausts at a strong 450 MAX Blower CFM.
- Smooth-flow blower wheel design and high flow filters ensure quiet, <0.5 sone operation at normal speed.
- Bright, three-level LED modules—supported by a 3-year warranty—illuminate evenly and are tested in cooking environments to ensure long life without dimming.
- Three-speed, whisper touch infrared control is a pleasure to use and admire. Delay off feature runs the blower for 10 minutes after cooking to clear the air.
- Broan Heat Sentry™ detects excessive heat and adjusts the blower speed to prolong the life of the product and provide proper ventilation.
- Dishwasher-safe, hybrid baffle filters provide ultra-efficient grease removal with superior air flow. The filter clean reminder ensures they will always maintain a high level of capture.
- EZ1 brackets make it easy for single-person installation in less than half the time of traditional methods.
- ADA compliant, remote operation is possible using a standard UL approved wall switch (kit sold separately).
- Non-duct capable with use of charcoal filters, sold separately. Hidden louvers on top of hood exhaust away from cabinetry.
- Optional HCR3 handheld remote enables control from anywhere in the kitchen.



HCR3 Optional Handheld Remote

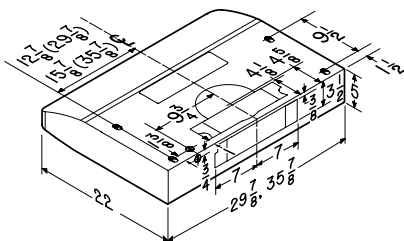

### SPECIFICATIONS

Width	MAX Blower CFM	Sones†	Volts	Amps	Duct
30"	450	<0.5	120	1.4	3-1/4" x 10" or 7" RD
36"					

### OPTIONAL ACCESSORIES

Non-Ducted Charcoal Filter	ADA Electronic Adapter Kit*	Handheld Remote	Make-Up Air Dampers
HPF30 (Type Xc)	HAWRK3	HCR3	MD6TU, MD8TU, MD10TU
HPF36 (Type Xd)			

\* Kit sold separately.

† Sones at normal (or working) speed.





## ALTA



**STAINLESS**  
30" 36"  
ALT230SS  
ALT236SS



**BLACK**  
30" 36"  
ALT230BL  
ALT236BL

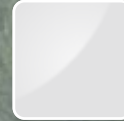

**WHITE**  
30" 36"  
ALT230WW  
ALT236WW



**BLACK STAINLESS**  
30" 36"  
ALT230BLS  
ALT236BLS

**The sculpted lines of Alta®** bring an exciting, new choice to typical range hood shapes. Wide curves and tap touch controls present a clean, striking design.

- The Captur™ system's advanced blower design features a forward positioned centric inlet to remove smoke and odor faster. Three-speed blower control exhausts at 375 MAX Blower CFM.
- Smooth-flow blower wheel design and high flow filters ensure quiet, 1.5 sone operation at normal speed.
- Bright, two-level LED modules—supported by a 3-year warranty—illuminate evenly and are tested in cooking environments to ensure long life without dimming.
- Tap-touch, 3-speed capacitive control features a smooth, easy-to-clean surface.
- Dishwasher-safe, deluxe micro-mesh filters provide highly efficient grease removal and patterned cover provides a decorative complement to the hood design. The filter clean reminder ensures they will always maintain a high level of capture.
- EZ1 brackets make it easy for single-person installation in less than half the time of traditional methods.
- ADA compliant, remote operation is possible using a standard UL approved wall switch (kit sold separately).
- Non-duct capable with use of charcoal filters, sold separately. Hidden louvers on top of hood exhaust away from cabinetry.

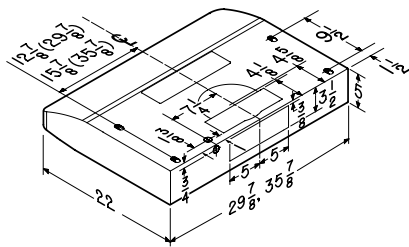

### SPECIFICATIONS

Width	MAX Blower CFM	Sones†	Volts	Amps	Duct
30"	375	1.5	120	.65	3-1/4" x 10" or 7" RD
36"					

\* Kit sold separately.  
† Sones at normal (or working) speed.

### OPTIONAL ACCESSORIES

Non-Ducted Charcoal Filter	ADA Electronic Adapter Kit*
HPF30 (Type Xc)	HAWRK3
HPF36 (Type Xd)	



## ALTA1



**STAINLESS**  
30" 36"  
ALT130SS  
ALT136SS



**BLACK**  
30" 36"  
ALT130BL  
ALT136BL



**WHITE**  
30" 36"  
ALT130WW  
ALT136WW

**The sculpted lines of Alta®** bring an exciting, new option to typical range hood shapes. Brilliant halogen lighting and hidden controls offer a beautiful alternative to traditional designs.

- The Captur™ system's advanced blower design features a forward positioned centric inlet to remove smoke and odor faster. Three-speed blower control exhausts at 300 MAX Blower CFM.
- Forward placement and smooth-flow blower wheel design ensure quiet, 1.5 sone operation at normal speed.
- Two-level, halogen bulbs illuminate the cooktop and counter area (bulbs included).
- Hidden on/off rocker switches control blower speeds and light levels.
- Dishwasher-safe, micro-mesh filters provide efficient grease removal.
- EZ1 brackets enable single-person installation in less than half the time of traditional methods.
- ADA compliant, remote operation is possible using a standard UL approved wall switch.
- Non-duct capable with use of charcoal filters, sold separately. Hidden louvers on top of hood exhaust away from cabinetry.

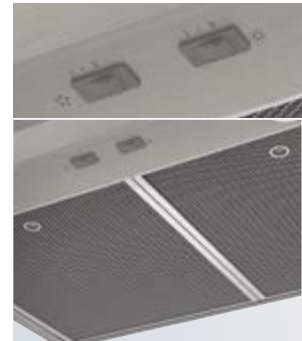

### Captur™

For faster smoke and odor removal.

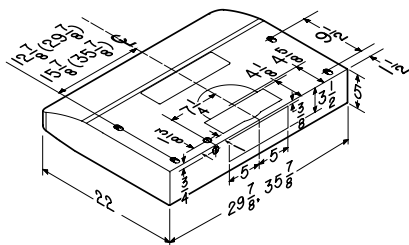

#### SPECIFICATIONS

Width	MAX Blower CFM	Sones†	Volts	Amps	Duct
30"	300	1.5	120	1.4	3-1/4" x 10" or 7" RD
36"					

† Sones at normal (or working) speed.

#### OPTIONAL ACCESSORIES

Non-Ducted Charcoal Filter
HPF30 (Type Xc)
HPF36 (Type Xd)



## TEN2



**STAINLESS**  
30" 36" 42"  
TEN230SS  
TEN236SS  
TEN242SS



**BLACK**  
30" 36"  
TEN230BL  
TEN236BL



**WHITE**  
30" 36"  
TEN230WW  
TEN236WW

**Tenaya is a slim, transitional design** with gentle radius features that make it perfect for today's contemporary kitchens. This beautiful design includes features that make it a pleasure to use and easy to maintain.

- The Captur™ system's advanced blower design features a forward positioned centric inlet to remove smoke and odor faster. Three-speed blower control exhausts at 375 MAX Blower CFM.
- Smooth-flow blower wheel design and high flow filters ensure quiet, 1.5 sone operation at normal speed.
- Bright, two-level LED modules—supported by a 3-year warranty—illuminate evenly and are tested in cooking environments to ensure long life without dimming.
- Tap-touch, 3-speed capacitive control features a smooth, easy-to-clean surface.
- Dishwasher-safe, micro-mesh filters provide efficient grease removal. The filter clean reminder ensures they will always maintain a high level of capture.
- EZ1 brackets make it easy for single-person installation in less than half the time of traditional methods.
- ADA compliant, remote operation is possible using a standard UL approved wall switch (kit sold separately).
- Non-duct capable with use of charcoal filters, sold separately. Hidden louvers on top of hood exhaust away from cabinetry.



### Captur™

For faster smoke and odor removal.

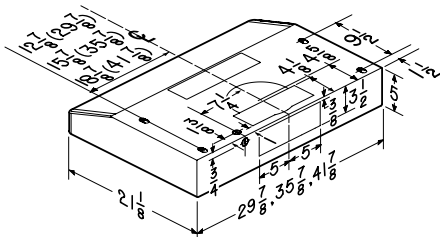

### SPECIFICATIONS

Width	MAX Blower CFM	Sones†	Volts	Amps	Duct
30"	375	1.5	120	.65	3-1/4" x 10" or 7" RD
36"					
42"					

### OPTIONAL ACCESSORIES

Non-Ducted Charcoal Filter	ADA Electronic Adapter Kit*
HPF30 (Type Xc)	HAWRK3
HPF36 (Type Xd)	
HPF42 (Type Xe)	

\* Kit sold separately.

† Sones at normal (or working) speed.







## TEN1



**STAINLESS**  
30" 36"  
TEN130SS  
TEN136SS



**BLACK**  
30" 36"  
TEN130BL  
TEN136BL



**WHITE**  
30" 36"  
TEN130WW  
TEN136WW

**Slim lines and graceful radiuses** combine to make Tenaya the perfect companion to today's contemporary kitchens. This beautiful design includes halogen lighting to light the cooktop and make cooking a pleasure.

- The Captur™ system's advanced blower design features a forward positioned centric inlet to remove smoke and odor faster. Two-speed blower control exhausts at 300 MAX Blower CFM.
- Smooth-flow blower wheel design and high flow filters ensure quiet, 1.5 sone operation at normal speed.
- Two-level, halogen bulbs flood the cooktop and surrounding area with generous illumination. (50W bulbs sold separately)
- Hidden on/off rocker switches controls two blower speeds and light levels.
- Large dishwasher-safe, single open-mesh filter provides efficient grease removal.
- ADA compliant, remote operation is possible using a standard UL approved wall switch.
- Non-duct capable with use of charcoal filters, sold separately. Hidden louvers on top of hood exhaust away from cabinetry.

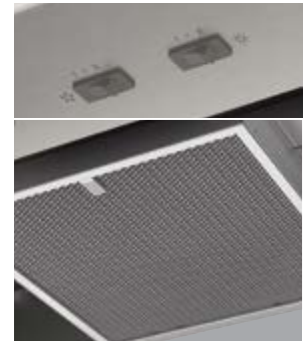

### Captur™

For faster smoke and odor removal.

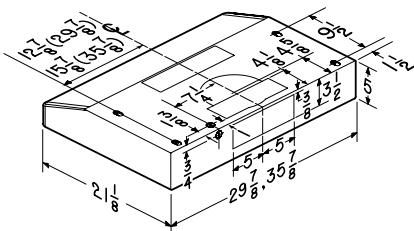

#### SPECIFICATIONS

Width	MAX Blower CFM	Sones†	Volts	Amps	Duct
30"	300	1.5	120	1.4	3-1/4" x 10" or 7" RD
36"					

† Sones at normal (or working) speed.

#### OPTIONAL ACCESSORIES

Non-Ducted Charcoal Filter
HPF1 (Type Xa)



## BPDP1



**STAINLESS**

**30" 36" 42" 48"**

BPDP130SS

BPDP136SS

BPDP142SS

BPDP148SS

**Broan brings you Spire, an exciting new shape in a pro-style hood.** The new design incorporates modern features like the quiet Captur™ system and LED lighting.

- The Captur™ system's advanced blower design features a forward positioned centric inlet to remove smoke and odor faster. Two-speed blower control exhausts at a strong 450 MAX Blower CFM.
- Smooth-flow blower wheel design and high flow filters ensure quiet operation; as low as 0.4 sones in some duct configurations.
- Bright, single intensity LED modules—supported by a 3-year warranty—illuminate evenly and are tested in cooking environments to ensure long life without dimming.
- Streamlined, deluxe 2-speed rocker control operates light and fan speeds.
- Pro-style, dishwasher-safe, hybrid baffle filters provide ultra-efficient grease removal with superior air flow.
- EZ1 brackets make it easy for singleperson installation in less than half the time of traditional methods.
- ADA compliant, remote operation is possible using a standard UL approved wall switch.
- Non-duct capable with use of charcoal filters, sold separately. Hidden louvers on top of hood exhaust away from cabinetry.



### Captur™

For faster smoke and odor removal.

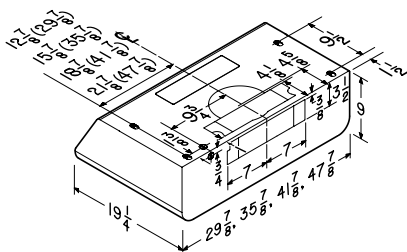

#### SPECIFICATIONS

Width	MAX Blower CFM*	Blower	Sones†	Volts	Amps	Duct	OPTIONAL ACCESSORIES	
							Non-Ducted Charcoal Filter	Make-up Air Damper
30", 36", 42", 48"	450	Internal	0.4	120	1.4	3-1/4" x 10" (V, H) 7" RD	HPF24 (Type Xb) HPF30 (Type Xc) HPF36 (Type Xd) HPF42 (Type Xe)	MD6TU, MD8TU, MD10TU

\* MAX Blower CFM indicates hood blower performance in open air. Find HVI rated performance for this model in the product specification sheet at Broan-NuTone.com

† Sones at normal (or working) speed.



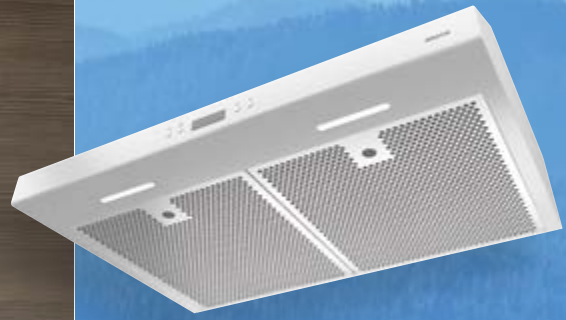

## BCDJ1



**STAINLESS**  
30" 36" 42"  
BCDJ130SS  
BCDJ136SS  
BCDJ142SS



**BLACK**  
30" 36" 42"  
BCDJ130BL  
BCDJ136BL



**WHITE**  
30" 36" 42"  
BCDJ130WH  
BCDJ136WH

**The luxury of an LCD display and deluxe micro-mesh filters will make any meal preparation delightful.** And, the Glacier range hood's contemporary shape complements any kitchen design.

- The Captur™ system's advanced blower design features a forward positioned centric inlet to remove smoke and odor faster. A smooth-flow blower wheel and high flow filters ensure quiet operation.
- A strong 450 MAX Blower CFM operates as quietly as 0.4 sones at normal speed.
- Bright, three-level LED modules—supported by a 3-year warranty—illuminate evenly and are tested in cooking environments to ensure long life without dimming.
- Three-speed electronic pushbutton control incorporates an LCD display to show hood status for fan and light setting, filter clean reminder, Heat Sentry™ and delay off.
- Broan Heat Sentry™ detects excessive heat and adjusts the blower speed to prolong the life of the product and provide proper ventilation.
- Dishwasher-safe, deluxe micro-mesh filters provide highly efficient grease removal and patterned cover provides a decorative complement to the hood design. The filter clean reminder ensures they will always maintain a high level of efficiency.
- EZ1 brackets make it easy for single-person installation in less than half the time of traditional methods.
- ADA compliant, remote operation.
- Non-duct capable with use of charcoal filters, sold separately. Hidden louvers on top of hood exhaust away from cabinetry.

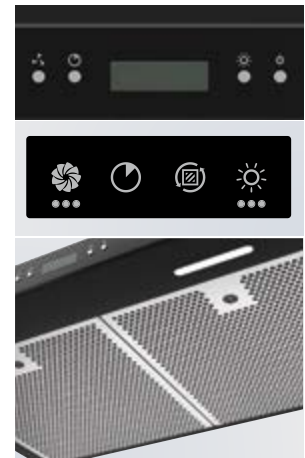

### Captur™

For faster smoke and odor removal.

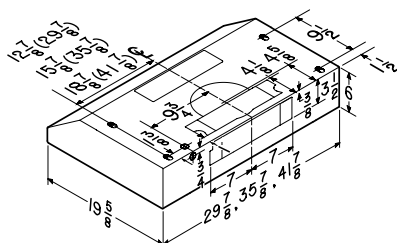

#### SPECIFICATIONS

Width	MAX Blower CFM*	Blower	Sones†	Volts	Amps	Duct
30", 36", 42"	450	Internal	0.4	120	1.4	3-1/4"x10" or 7" RD

#### OPTIONAL ACCESSORIES

Non-Ducted Charcoal Filter	ADA Electronic Adapter Kit
HPF30 (Type Xc)	HAWRK3
HPF36 (Type Xd)	
HPF42 (Type Xe)	

\* MAX Blower CFM indicates hood blower performance in open air. Find HVI rated performance for this model in the product specification sheet at Broan-NuTone.com  
† Sones at normal (or working) speed.





## BCDF1



**STAINLESS**  
30" 36" 42"  
BCDF130SS  
BCDF136SS  
BCDF142SS



**BLACK STAINLESS**  
30" 36"  
BCDF130BLS  
BCDF136BLS

**The clean, contemporary shape of Glacier complements any kitchen design.** Impressive LED lighting and superior smoke and odor removal are a mere introduction to everything this hood has to offer.

- The Captur™ system's advanced blower design features a forward positioned centric inlet to remove smoke and odor faster. A smooth-flow blower wheel and high flow filters ensure quiet operation.
- 375 MAX Blower CFM operates at 2.0 sones at normal speed; as low as 1.5 sones in some duct configurations.
- Bright, two-level LED modules—supported by a 3-year warranty—illuminate evenly and are tested in cooking environments to ensure long life without dimming.
- Tap-touch, three-speed capacitive control features a smooth, easy-to-clean surface.
- Dishwasher-safe, micro-mesh filters provide efficient grease removal. The filter clean reminder ensures they will always maintain a high level of capture.
- EZ1 brackets make it easy for single-person installation in less than half the time of traditional methods.
- ADA compliant, remote operation.
- Non-duct capable with use of charcoal filters, sold separately. Hidden louvers on top of hood exhaust away from cabinetry.



### Captur™

For faster smoke and odor removal.

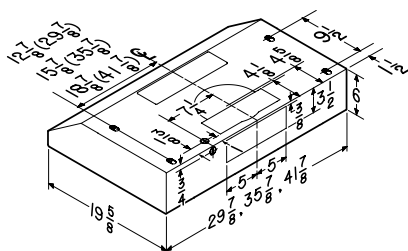

#### SPECIFICATIONS

Width	MAX Blower CFM*	Blower	Sones†	Volts	Amps	Duct
30", 36", 42"	375	Internal	2.0	120	.65	3-1/4" x 10" (V, H) 7" RD

#### OPTIONAL ACCESSORIES

Non-ducted Charcoal Filter	ADA Electronic Adapter Kit
HPF30 (Type Xc)	HAWRK3
HPF36 (Type Xd)	
HPF42 (Type Xe)	

\* MAX Blower CFM indicates hood blower performance in open air. Find HVI rated performance for this model in the product specification sheet at Broan-NuTone.com  
† Sones at normal (or working) speed.





# BCSD1



## STAINLESS

- 24" BCSD124SS
- 30" BCSD130SS
- 36" BCSD136SS
- 42" BCSD142SS



## BLACK

- 24" BCSD124BL
- 30" BCSD130BL
- 36" BCSD136BL
- 42" BCSD142BL



## WHITE

- 24" BCSD124WW
- 30" BCSD130WW
- 36" BCSD136WW
- 42" BCSD142WW



## BISQUE

- 30" BCSD130BC
- 36" BCSD136BC

**The clean, contemporary shape of Glacier complements any kitchen design.** This new design has features like the quiet Captur™ system and brilliant halogen lighting.

- The Captur™ system's advanced blower design features a forward positioned centric inlet to remove smoke and odor faster. A smooth-flow blower wheel and high flow filters ensure quiet operation.
- 300 MAX Blower CFM operates at 1.5 sones at normal speed.
- Two-level, halogen bulbs flood the cooktop and surrounding area with generous illumination (50W bulbs not included).
- Hidden two-speed on/off rocker switch.
- Dual dishwasher-safe, open-mesh filters provide efficient grease removal.
- EZ1 brackets make it easy for single-person installation in less than half the time of traditional methods.
- ADA compliant, remote operation is possible using a standard UL approved wall switch.
- Non-duct capable with use of charcoal filters, sold separately. Hidden louvers on top of hood exhaust away from cabinetry.



## Captur™

For faster smoke and odor removal.

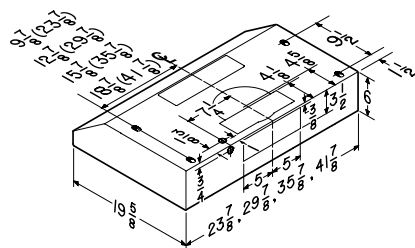

### SPECIFICATIONS

Width	MAX Blower CFM*	Blower	Sones†	Volts	Amps	Duct
24", 30", 36", 42"	300	Internal	1.5	120	1.4	3-1/4" x 10" (V, H) 7" RD

### OPTIONAL ACCESSORIES

Non-Ducted Charcoal Filter
HPF24 (Type Xb)
HPF30 (Type Xc)
HPF36 (Type Xd)
HPF42 (Type Xe)

\* MAX Blower CFM indicates hood blower performance in open air. Find HVI rated performance for this model in the product specification sheet at Broan-NuTone.com

† Sones at normal (or working) speed.







## BKSH1



**STAINLESS**  
30"  
BKSH130SS



**BLACK**  
30"  
BKSH130BL



**WHITE**  
30"  
BKSH130WW

**The slim and refined lines of Sahale bring a refreshing change to today's kitchens.** Brilliant halogen lighting and a deluxe rocker control complements your cooking experience.

- The Captur™ system's advanced blower design features a forward positioned centric inlet to remove smoke and odor faster. A smooth-flow blower wheel and high flow filters ensure quiet operation.
- 300 MAX Blower CFM operates at 1.5 sones at normal speed.
- Two-level, halogen bulbs flood the cooktop and surrounding area with generous illumination (bulbs included).
- Streamlined, deluxe rocker control operates two fan speeds.
- Dishwasher-safe, micro-mesh filters provide efficient grease removal.
- EZ1 brackets make it easy for single-person installation in less than half the time of traditional methods.
- ADA compliant, remote operation is possible using a standard UL approved wall switch.
- Non-duct capable with use of charcoal filters, sold separately. Hidden louvers on top of hood exhaust away from cabinetry.



### Captur™

For faster smoke and odor removal.

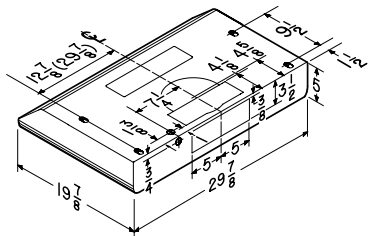

#### SPECIFICATIONS

Width	MAX Blower CFM*	Blower	Sones†	Volts	Amps	Duct
30"	300	Internal	1.5	120	1.4	3-1/4" x 10" (V, H) 7" RD

#### OPTIONAL ACCESSORIES

Non-ducted Charcoal Filter
HPF30 (Type Xc)

\* MAX Blower CFM indicates hood blower performance in open air. Find HVI rated performance for this model in the product specification sheet at Broan-NuTone.com  
† Sones at normal (or working) speed.



## BKSA1



**STAINLESS**  
30"  
BKSA130SS



**BLACK**  
30"  
BKSA130BL



**WHITE**  
30"  
BKSA130WW

**The slim and refined lines of Sahale bring a refreshing change to today's kitchens.** Brilliant halogen lighting and hidden rocker controls complements your cooking experience.

- The Captur™ system's advanced blower design features a forward positioned centric inlet to remove smoke and odor faster. A smooth-flow blower wheel and high flow filters ensure quiet operation.
- 300 MAX Blower CFM operates at 1.5 sones at normal speed.
- Two-level, halogen bulbs flood the cooktop and surrounding area with generous illumination (bulbs included)
- Hidden two-speed on/off rocker switch.
- Large dishwasher-safe, single open-mesh filter provides efficient grease removal.
- ADA compliant, remote operation is possible using a standard UL approved wall switch.
- Non-duct capable with use of charcoal filter, sold separately. Hidden louvers on top of hood exhaust away from cabinetry.



### Captur™

For faster smoke and odor removal.

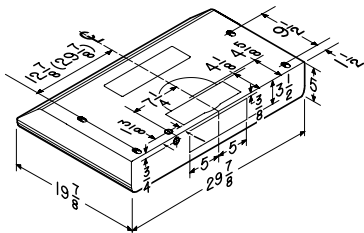

#### SPECIFICATIONS

Width	MAX Blower CFM*	Blower	Sones†	Volts	Amps
30"	300	Internal	1.5	120	1.4

#### OPTIONAL ACCESSORIES

Duct	Non-ducted Charcoal Filter
3-1/4" x 10" (V, H) 7" RD	HPF1 (Type Xa)

\* MAX Blower CFM indicates hood blower performance in open air. Find HVI rated performance for this model in the product specification sheet at Broan-NuTone.com  
† Sones at normal (or working) speed.



## BXT1



**STAINLESS**  
30"  
BXT130SS



**BLACK**  
30"  
BXT130BL



**WHITE**  
30"  
BXT130WW

**With gentle round surfaces this transitional hood design** is a great choice for contemporary kitchens. Hidden rocker switches conveniently control blower operation and bright LED lighting. A dishwasher-safe filter, integrated light panel and top side recirculation louvers clean easily.

- 270 MAX Blower CFM provides adequate capture and operates at 2.0 sones at normal speed.
- One-level LED lighting illuminates the cooking surface.
- 4-way convertibility enables flexible installation in ducted or non-ducted applications.
- Hidden two-speed on/off rocker switch.
- Large dishwasher safe, single aluminum mesh filter provides efficient grease removal.
- ADA compliant, remote operation is possible using a standard UL approved wall switch.
- Non-duct capable with use of charcoal filter, sold separately. Hidden louvers on top of hood exhaust away from cabinetry.

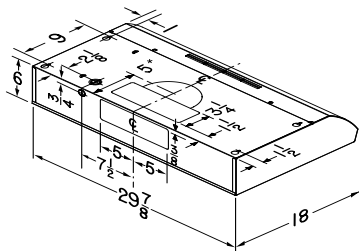

### SPECIFICATIONS

Width	MAX Blower CFM*	Blower	Sones†	Volts	Amps	Duct	OPTIONAL ACCESSORIES Non-duct Charcoal Filter
30"	270	Internal	2.0	120	1.3	3-1/4" x 10" (V,H) 7" RD	HPFX1

\* MAX Blower CFM indicates hood blower performance in open air. Find HVI rated performance for this model in the product specification sheet at Broan-NuTone.com

† Sones at normal (or working) speed.



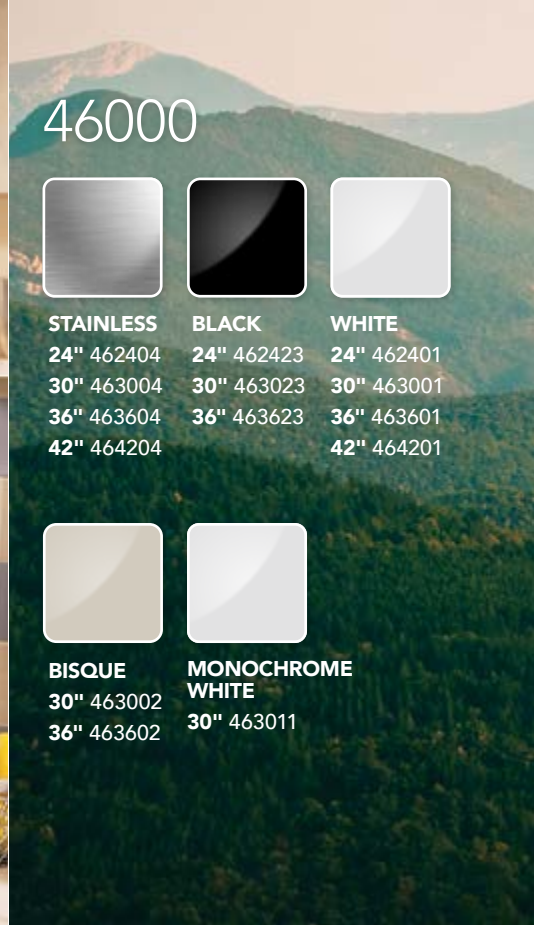

46000



**STAINLESS**  
24" 462404  
30" 463004  
36" 463604  
42" 464204



**BLACK**  
24" 462423  
30" 463023  
36" 463623



**WHITE**  
24" 462401  
30" 463001  
36" 463601  
42" 464201



**BISQUE**  
30" 463002  
36" 463602



**MONOCHROME  
WHITE**  
30" 463011

### Deluxe, variable-speed performance in an economical package.

The infinitely adjustable speed control allows you to set the hood speed for the perfect combination of ventilation and quiet.

- 260 MAX Blower CFM (7" round), 2.5 sones at normal speed.
- Easily installs as 7" round vertical discharge; 3-1/4" x 10" vertical discharge; 3-1/4" x 10" horizontal discharge or non-ducted (non-ducted filter sold separately).
- Rotary, infinitely adjustable fan-speed control.
- Up to 75-watt cooktop lighting with protective polymeric lens and two-level light control (bulb not included).
- Includes 3-1/4" x 10" damper/adaptor and 7" round adaptor.
- 7" round damper optional.
- BP87Q damper sold separately.
- ADA compliant, remote operation is possible using a standard UL approved wall switch.

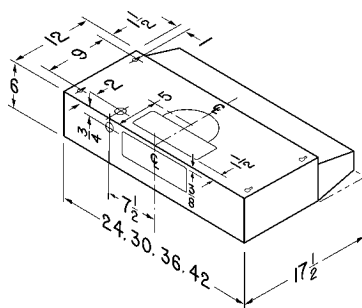

#### SPECIFICATIONS

Width	MAX Blower CFM**	Blower	Sones†	Volts	Amps	Duct	Non-ducted Filter	7" RD Damper
24", 30", 36", 42"	260	Internal	2.5	120	2.5	3-1/4" x 10" or 7" RD	41F	BP87Q

#### OPTIONAL ACCESSORIES

\* Special Order: Allow three weeks for delivery.

\*\*MAX Blower CFM indicates hood blower performance in open air. Find HVI rated performance for this model in the product specification sheet at Broan-NuTone.com

† Sones at normal (or working) speed.



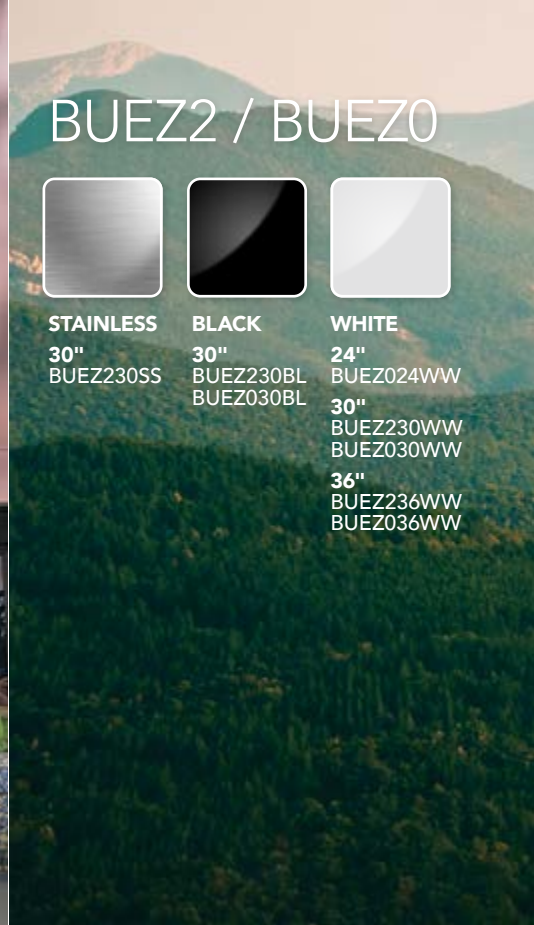

## BUEZ2 / BUEZ0



**STAINLESS**  
30"  
BUEZ230SS



**BLACK**  
30"  
BUEZ230BL  
BUEZ030BL



**WHITE**  
24"  
BUEZ024WW  
30"  
BUEZ230WW  
BUEZ030WW  
36"  
BUEZ236WW  
BUEZ036WW

**Introducing our easy installation system** to Broan's economy range hood offering. Broan range hoods provide the high quality you expect and the value you demand.

### BUEZ2

- Installs as 7" round ducted only; built-in 7" adapter included.
- EZ1 installation kit included.
- 190 CFM, 6.0 sone (vertical discharge) performance.
- Dishwasher-safe aluminum grease filter.
- Accepts up to 75-watt light (bulb sold separately).
- BP87Q damper sold separately.
- ADA compliant, remote operation using a standard UL approved wall switch.

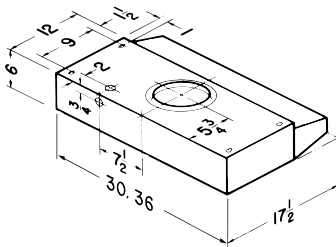

### BUEZ0

- Installs as 3-1/4" x 10" ducted only; built-in adapter/damper included.
- EZ1 installation kit included.
- 160 CFM, 6.5 sone (vertical or horizontal discharge) performance.
- Dishwasher-safe aluminum grease filter.
- Accepts up to 75-watt light (bulb sold separately).
- ADA compliant, remote operation using a standard UL approved wall switch.

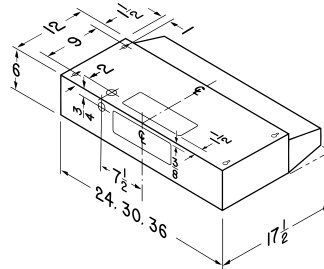

#### BUEZ0 SPECIFICATIONS

Width	CFM	Blower	Sones	Volts	Amps	Duct
24", 30", 36"	160	Internal	6.5	120	2.0	3-1/4" x 10"

#### BUEZ2 SPECIFICATIONS

Width	CFM	Blower	Sones	Volts	Amps	Duct
30", 36"	190	Internal	6	120	2.5	7" RD

#### OPTIONAL ACCESSORIES

7" RD Damper
BP87Q

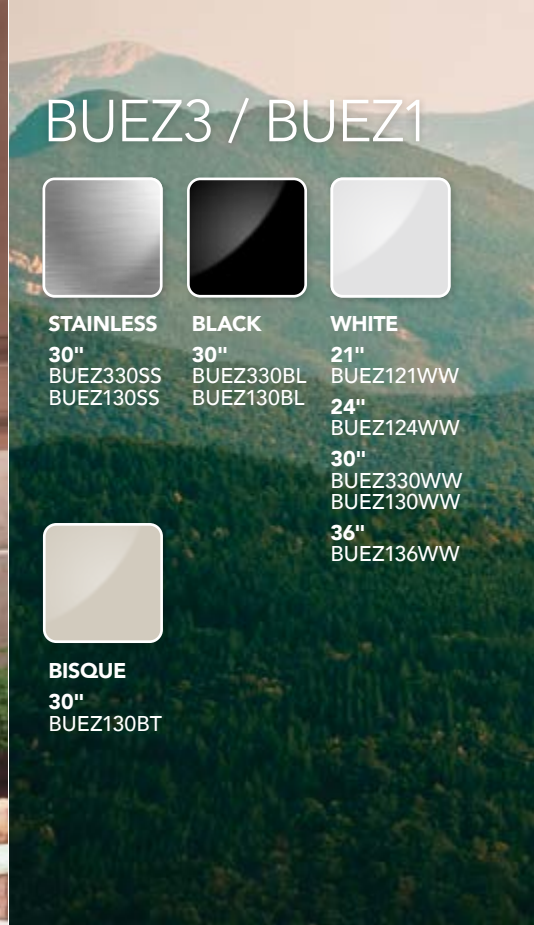

# BUEZ3 / BUEZ1



**STAINLESS**  
30"  
BUEZ330SS  
BUEZ130SS



**BLACK**  
30"  
BUEZ330BL  
BUEZ130BL



**WHITE**  
21"  
BUEZ121WW  
24"  
BUEZ124WW  
30"  
BUEZ330WW  
BUEZ130WW  
36"  
BUEZ136WW



**BISQUE**  
30"  
BUEZ130BT

**Introducing our easy installation system** to Broan's economy range hood offering. Broan range hoods provide the high quality you expect and the value you demand.

## BUEZ3

- Features enclosed light and fan/filter assembly for easy clean-up.
- EZ1 installation kit included.
- Two-speed, rocker-type fan control.
- Powerful 190 CFM, 7.0 sone (3-1/4" x 10" vertical discharge) or 220 CFM, 8.0 sone (7" round discharge) performance.
- Accepts up to 75-watt light (bulb not included).
- Includes 3-1/4" x 10" damper/adaptor and built-in 7" round adapter.
- 7" round damper optional.
- BP87Q dampers sold separately.
- ADA compliant, remote operation using a standard UL approved wall switch.

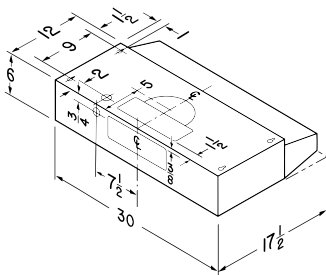

## BUEZ1

- Installs as non-ducted only with charcoal filter.
- EZ1 installation kit included.
- Accepts up to 75-watt light (bulb sold separately).
- ADA compliant, remote operation using a standard UL approved wall switch.

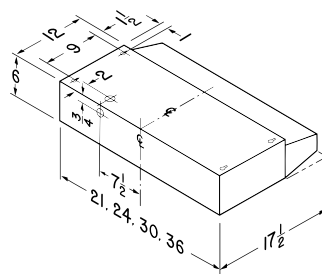

### BUEZ1 SPECIFICATIONS

Width	CFM	Sones	Volts	Amps
21", 24", 30", 36"	N/A	N/A	120	2.0

### OPTIONAL ACCESSORIES

Duct	Charcoal Filter
Non-ducted	41F

### BUEZ3 SPECIFICATIONS

Width	CFM	Blower	Sones	Volts	Amps
30"	190	Internal	7.0	120	1.8
	220		8.0		

### OPTIONAL ACCESSORIES

Duct	Charcoal Filter	7" RD Damper
3-1/4" x 10" 7" RD	BP58	BP87Q









42000/40000/  
37000



**STAINLESS**

24" 422404  
402404

30" 423004  
403004

36" 423604  
403604

42" 424204

**6" SHELL  
ONLY**

30" 373004

36" 373604



**BISQUE**

30" 423002  
403002



**MONOCHROME  
WHITE**

21" 402101

24" 422401  
402401

30" 423001  
403001

36" 423601  
403601

42" 424201  
404201

**6" SHELL ONLY**

24" 372401

30" 373001

36" 373601



**BLACK**

30" 423023, 403023

36" 423623, 403623

**Broan range hoods** provide the high quality you expect and the value you demand.

## 42000 SERIES

- Installs as 7" round ducted only.
- 230 MAX Blower CFM (7" round), 6.0 sones.
- Dishwasher-safe aluminum grease filter.
- Accepts up to 75-watt light (bulb sold separately).
- Built-in 7" adapter included.
- BP87Q damper sold separately.
- ADA compliant, remote operation using a standard UL approved wall switch.

## 40000 SERIES

- Installs as 3-1/4" x 10" ducted only.
- 210 MAX Blower CFM, 6.5 sones.
- Dishwasher-safe aluminum grease filter.
- Accepts up to 75-watt light (bulb sold separately).
- Duct connector with built-in damper included.
- ADA compliant, remote operation using a standard UL approved wall switch.

## 37000 SERIES— 6" SHELL ONLY

- The 37000 Series utilizes the 40000 Series, but contains no fan, light or switch knock-outs.

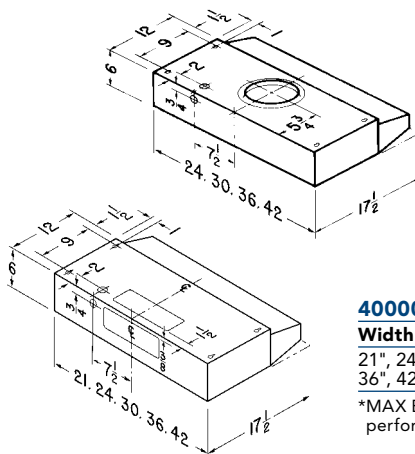

### 42000 SPECIFICATIONS

Width	MAX Blower CFM*	Blower	Sones	Volts	Amps	Duct	OPTIONAL ACCESSORIES
							7" RD Damper
24", 30", 36", 42"	230	Internal	6	120	2.5	7" RD	BP87Q

\*MAX Blower CFM indicates hood blower performance in open air. Find HVI rated performance for this model in the product specification sheet at [Broan-NuTone.com](http://Broan-NuTone.com)

### 40000 SPECIFICATIONS

Width	MAX Blower CFM*	Blower	Sones	Volts	Amps	Duct
21", 24", 30", 36", 42"	210	Internal	6.5	120	2.0	3-1/4" x 10"

\*MAX Blower CFM indicates hood blower performance in open air. Find HVI rated performance for this model in the product specification sheet at [Broan-NuTone.com](http://Broan-NuTone.com)

**BROAN**

**HVI**  
CERTIFIED



41000



**STAINLESS**

24" 412404  
30" 413004  
36" 413604  
42" 414204



**BLACK**

21" 412123  
30" 413023  
36" 413623

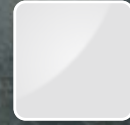

**MONOCHROME  
WHITE**

21" 412101  
24" 412401  
30" 413001  
36" 413601  
42" 414201



**BISQUE**

30" 413002

**Broan range hoods** provide the high quality you expect and the value you demand.

- Installs as non-ducted only with charcoal filter.
- Accepts up to 75-watt light (bulb sold separately).
- ADA compliant, remote operation is possible using a standard UL approved wall switch.

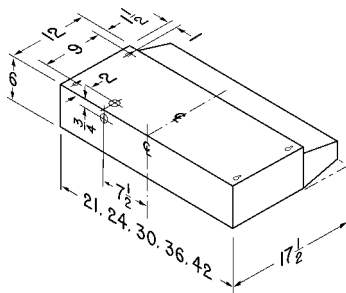

**SPECIFICATIONS**

Width	CFM	Sones	Volts	Amps	Duct	Charcoal Filter
21", 24", 30", 36", 42"	N/A	N/A	120	2.0	Non-ducted	41F

**OPTIONAL ACCESSORIES**





Shown: BPDP1 on page 55

# Metal Backsplashes

Help keep your kitchen looking like new.



## STAINLESS STEEL

24" SP2404  
30" SP3004  
36" SP3604  
42" SP4204

- Provides easy clean-up of cooking splatter.
- Durable, attractive appliance-matching finishes: Reversible White/Almond, Reversible Bisque/Black.



## REVERSIBLE BISQUE /BLACK

24" SP240223  
30" SP300223  
36" SP360223

- Aluminum or 24-gauge stainless steel.
- Available in 24", 30", 36" or 42" widths; all are 24" high.
- Installs easily with four screws (not included).



## REVERSIBLE WHITE/ALMOND

24" SP240108  
30" SP300108  
36" SP360108



# Replacement Grease Filters and Charcoal Filters

Genuine Broan replacement grease filters and odor-capturing non-ducted charcoal filters are the key to removing cooking effluents from your kitchen. The table below will help you find the filter model matched to your Broan range hood. Select filters are interchangeable on select hoods.

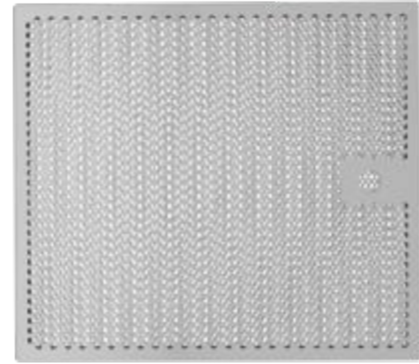
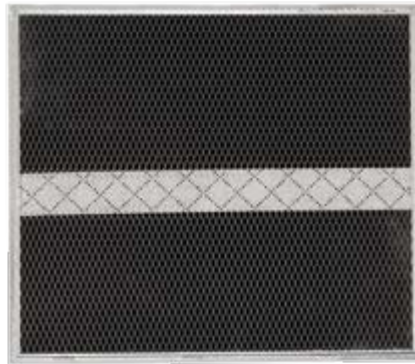
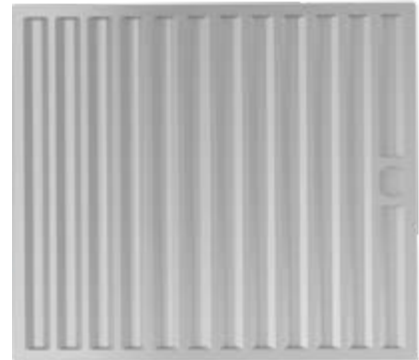
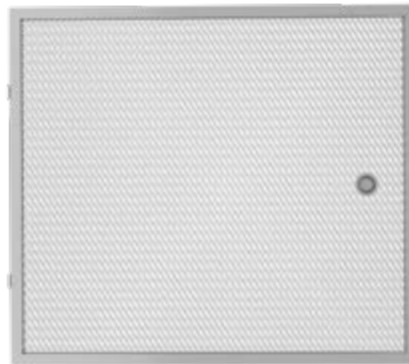

FITS RANGE HOOD SERIES	NON-DUCTED CHARCOAL FILTER	REPLACEMENT GREASE FILTER	DESCRIPTION
<b>RMIP33</b>		RBFI33	
<b>RMIP45</b>		RBFI45	
<b>RM50000, RMP17004</b>	FILTEREB40		
<b>E54000</b>	FILTERSQUARE		
<b>41000, F40000, 46000, BUEZ1</b>	41F		
<b>40000, F40000, 42000, 46000, BUEZ0, BUEZ2</b>		BP29	
<b>43000, BUEZ3</b>	BP58		Qty 3
<b>43000, BUEZ3</b>		BP57 w/charcoal pad	w/light lens
<b>BCDF, BKDB, BKSH*</b>	HPF30 (Type Xc), HPF36 (Type Xd), HPF42 (Type Xe)	HPFAMM30 (C2), HPFAMM36 (D2), HPFAMM42 (E2)	Qty 2 for 30", 36", 42"
<b>BCDJ*</b>	HPF30 (Type Xc), HPF36 (Type Xd), HPF42 (Type Xe)	HPFA3B30 (C4), HPFA3B36 (D4), HPFA3B42 (E4)	Qty 2 for 30", 36", 42"
<b>BCSD, BCSEK*, ALT1, BCSD, BCSEK, TEN2*</b>	HPF30 (Type Xc), HPF36 (Type Xd), HPF42 (Type Xe)	HPFA130 (C1), HPFA136 (D1), HPFA142 (E1)	Qty 2 for 30", 36", 42"
<b>ALT2, BKDF*, BKDEG*</b>	HPF30 (Type Xc), HPF36 (Type Xd)	HPFA3A30 (C3), HPFA3A36 (D3)	Qty 2 for 30", 36"
<b>BKSA, TEN1*</b>	HPF1 (Type Xa)	HPFA (A0)	Qty 1 for 30"
<b>ALT3, BDP, SPE1*</b>	HPF24 (Type Xb), HPF30 (Type Xc), HPF36 (Type Xd), HPF42 (Type Xe)	HPFA424 (B5), HPFA430 (C5), HPFA436 (D5), HPFA442 (E5)	Qty 2 for 30", 36", 42", 48"
<b>ALT4</b>	HPF52 (Type Xh2)	HPFA52 (H2)	Qty 2 for 30", 36"

\*Filter type shown in parentheses.



# Make-up Air Dampers

Broan® Automatic Make-Up Air Dampers are the first to provide synchronized operation for kitchen, bath and whole-house ventilation products. Installation is simple and requires no special wiring. Intelligent design options ensure optimum performance in a variety of installations and applications. Highly effective and affordable, Broan Automatic Make-Up Air Dampers strike the perfect balance to keep you and your home breathing easy.



- Economical, ruggedly constructed galvanized motorized damper.
- Can be controlled by more than one Broan ventilation product.
- Damper opens automatically to replace the air being exhausted by ventilation fans or range hoods, and then closes tightly when ventilation fans are turned off.
- Prevents excess air from entering the home during heating or cooling operation, reducing energy consumption.
- Interlocked systems meet IRC code requirements for make-up air with range hoods.
- Fresh air inlets are required—see the table below.

## MD6TU/MD8TU/MD10TU Universal Design

- Works with any Broan range hood over 300 CFM.
- Provides interlocked make-up air.
- No direct wire connection required.
- Requires use of Broan fresh air inlets.

## MD6T/MD8T/MD10T

- Works with Broan range hood models: EI59, EW56, EW58, E64, E60.
- Requires direct wire to hood.
- Requires use of Broan fresh air inlets.

### FRESH AIR INLETS (REQUIRED)

Damper Model	Diameter	Fresh Air Inlet Model
MD6TU/MD6T	6"	641FA
MD8TU/MD8T	8"	643FA
MD10TU/MD10T	10"	610FA

Online Range Hood Make-Up Air Specifying Tool guides the design of the right make-up air damper system for any home. Try it at [broan-nutone.com/make-up-air](http://broan-nutone.com/make-up-air).



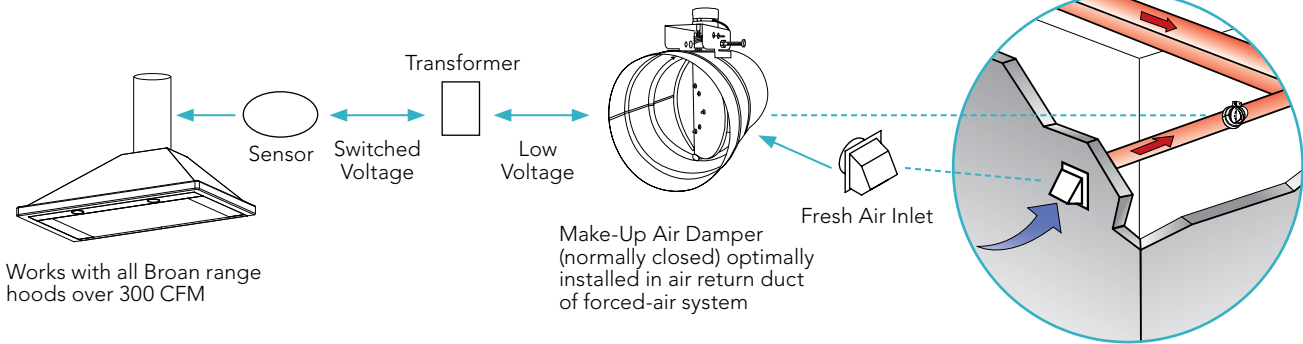



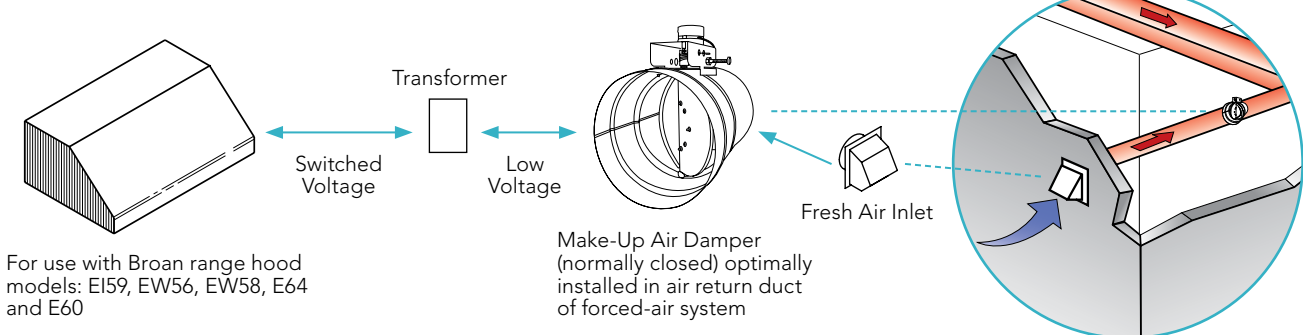



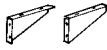



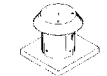

### MD6TU/8TU/10TU installation























### MD6T/8T/10T installation



# Ducting Installation Accessories

	Stock No.	Description
	<b>35</b>	Wall Hanging Kit—for mounting hoods to wall when not hung from overhead cabinets. Designed for use with 46000, 43000, 42000, 41000, F40000, 40000 series.
<b>AC Cord Kit</b>	<b>HCK44</b> <b>SHCK44</b>	HCK44 (10-pack) Electric cord connections kit. (Single-pack) Electric cord connections kit.
	<b>634</b>	Paintable roof cap with backdraft damper and bird screen; 3-1/4" x 10" or up to 8" round duct. Black finish.
	<b>644</b>	Aluminum roof cap with backdraft damper and bird screen; 3-1/4" x 10" or up to 8" round duct. Natural finish.
	<b>437</b>	High-capacity roof cap—up to 1200 CFM exhaust with spring-loaded damper and bird screen.
	<b>611</b>	Aluminum roof cap for flat roofs, 8" round duct.
	<b>612</b>	Aluminum roof cap for flat roofs, 10" round duct.
	<b>639</b>	Paintable wall cap with backdraft damper and bird screen; 3-1/4" x 10" duct. Black finish.
<b>WC638</b>		Paintable wall cap with backdraft damper and bird screen; 3-1/4" x 14" duct. Black finish.
	<b>649</b>	Aluminum wall cap with backdraft damper and bird screen; 3-1/4" x 10" duct. Natural finish.
	<b>641</b>	Aluminum wall cap for 6" round duct, with backdraft damper and bird screen.
	<b>641FA</b>	Aluminum fresh air inlet wall cap for 6" round duct.
	<b>647</b>	Aluminum wall cap for 7" round duct, with damper and bird screen.
	<b>610FA</b>	10" Aluminum Fresh air inlet.
	<b>643</b>	Aluminum wall cap; 8" round duct with damper.
	<b>643FA</b>	Aluminum fresh air inlet wall cap for 8" round duct.
	<b>441</b>	Wall cap with gravity damper; 13-1/8" sq. fits 10" round duct.
	<b>BP87Q</b>	7" round discharge damper with sound dampening.
	<b>97</b>	7" spring-loaded, In-Line damper.
	<b>438</b>	8" round section with In-Line damper.
	<b>421</b>	10" vertical discharge In-Line damper.

	Stock No.	Description
	<b>411</b>	3-1/4" x 10" to 6" round transition.
	<b>412H</b>	3-1/4" x 10" to 7" round transition.
	<b>T460</b>	3-1/4" x 14" to 7" round transition.
	<b>413</b>	3-1/4" x 10" to 8" round transition.
	<b>459</b>	3-1/4" x 14" to 8" round transition.
	<b>T461</b>	3-1/4" x 14" to 3-1/4" x 10" transition.
	<b>414</b>	8" to 10" expander.
	<b>889</b>	3-1/4" x 10" duct; 2' section.
	<b>406</b>	6" round duct; 2' section.
	<b>407</b>	7" round duct; 2' section.
	<b>408</b>	8" round duct; 2' section.
	<b>410</b>	10" round duct; 2' section.
	<b>428</b>	3-1/4" x 10" vertical elbow.
	<b>429</b>	3-1/4" x 10" horizontal elbow.
	<b>430</b>	Short eave elbow for 3 1/4" x 10" duct with backdraft damper and grill.
	<b>431</b>	Long eave elbow for 3 1/4" x 10" duct with backdraft damper and grill.
	<b>419</b>	6" adjustable elbow (individual).
	<b>415</b>	7" adjustable elbow (carton of four).
	<b>432</b>	8" adjustable elbow (individual).
	<b>418</b>	10" adjustable elbow (individual).
	<b>MD6S</b>	6" Slave Make-Up Air Damper.
	<b>MD8S</b>	8" Slave Make-Up Air Damper.
	<b>MD10S</b>	10" Slave Make-Up Air Damper.
	<b>MD6T</b>	6" Broan Make-Up Air Damper.
	<b>MD8T</b>	8" Broan Make-Up Air Damper.
	<b>MD10T</b>	10" Broan Make-Up Air Damper.
	<b>MD6TU</b>	6" Universal Make-Up Air Damper.
	<b>MD8TU</b>	8" Universal Make-Up Air Damper.
	<b>MD10TU</b>	10" Universal Make-Up Air Damper.

# Blowers

## External, Exterior Blowers\*



Model 331H/332H

**Our Exterior blowers offer you powerful ventilation performance at its very quietest, and something you won't find anywhere else—Broan quality.**

All Exterior blowers can be installed on the roof or to an outside wall for the ultimate in quiet, high performance kitchen ventilation. Quietest sound level is achieved when the blower is mounted at least 10' from the hood location and incorporates a 90 degree elbow in the duct run.

- Reduce kitchen noise by locating your range hood blower outdoors.
- For use with our professional style Broan Elite E64000, E60000, EX Series chimney hoods, downdrafts, RMPE Power Pack and RMIP Inserts.
- Ideal for custom hoods—use the 72W (6 amp variable speed) wall control for remote control of External blowers.
- The 332H is recommended for the Eclipse downdraft.
- Residential design fits unobtrusively on home exterior.
- Durable, weather-resistant, all-aluminum construction that mounts on the roof or outside wall.
- Safety screen keeps small animals and debris away from blower and motor.



331H (660 MAX Blower CFM)



335 (1280 MAX Blower CFM)



332H (880 MAX Blower CFM)



336 (1620 MAX Blower CFM)

## External, In-Line Blowers\*

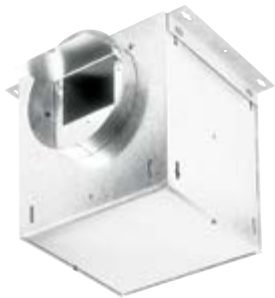

- HLB3 (320 MAX Blower CFM)
- HLB6 (670 MAX Blower CFM)
- HLB9 (890 MAX Blower CFM)
- HLB11 (1540 MAX Blower CFM)

**This quiet performance solution is a perfect alternative to Internal or Exterior blowers. Works with all Broan range hoods designed for use with External blowers.**

- Powerful and quiet, In-Line blowers are available in a range of CFM ratings to match your cooking preferences and ventilation requirements.
- Installs remotely in the interior of the home—not restricted by local exterior home codes or service concerns for roof-mounted exterior applications.

- Eight-position mounting brackets, or suspends with special suspension chains (hanger kit included).
- Designed to work independently from Internal or Exterior blowers, this is not a boost blower—the HLB series needs no other blowers in the system.
- Specially designed resilient motor mounts and housing isolation mounts prevent vibration noise.
- Flexible duct design allows straight-through or right-angle connections with built-in damper.
- Includes 10" round ductwork transition(s).

## Internal Blowers\*

P5 (530 MAX Blower CFM vertical)

P8 (930 MAX Blower CFM vertical)

Broan Elite Internal blowers provide high ventilation and durable construction to meet the needs of professional-style cooking appliances for the home.

- The P5 (530 MAX Blower CFM) and P8 (930 MAX Blower CFM) blowers are designed for use with RMIP Inserts.
- All blowers are designed for quiet operation using the finest motors and balance wheels.
- Rough-In Kits are included to make the installation clean and simple.

\* Broan internal and external blowers are designed and UL Listed for use with Broan products only. Use with other manufacturers' products cannot be recommended. Broan range hoods can be used to comply with California Title 24.





# Installation and Blower Selection Guidelines

## 1. Distance from cooking surface:

For optimal performance, the distance from the cooking surface to the bottom of the range hood should be between 24" to 30", unless otherwise noted. DO NOT install a Broan Elite range hood less than 24" above cooking surface.

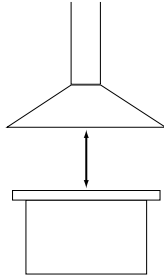

To maintain hood performance at heights greater than the recommended range, use the following guidelines:

- For every 3" increase in installation height, add 100 CFM to the minimum exhaust requirement and/or a minimum of 3" to the hood/liner width (may require going to the next hood width).

## 2. Range hood width:

The hood should never be less than the width of the cooktop.

## 3. Required blower CFM based on cooktop BTU output.

For gas cooktops under 60,000 BTUs, or electric choose a blower with a minimum of 100 CFM per lineal foot of your cooktop width. For example, a 36" wide cooktop requires a blower with a minimum of 300 CFM.

- High heat cooking or aromatic foods may require additional CFM. Always check with the range manufacturer. NOTE: Increasing capture area by 3" on each side is also a recommended way to address this issue.

- As a means to estimate the approximate CFM requirement for cooktops OVER 60,000 BTUs, choose a blower with 1 CFM per 100 BTU of cooktop output. To quickly calculate this number, add the BTU output from all burners and drop the last two zeros. For example, if the total BTU output of the cooktop burners is 65,000 BTUs, choose a blower with at least 650 CFM.

## 4. Additional CFM needs for a Grill or Griddle:

If your cooktop has a grill or griddle, ADD 200 CFM to your estimated CFM needs as calculated in step 3. For example, if your cooktop BTU output requires a 650 CFM blower, add 200 CFM for a total of 850 CFM.

## Installation Example:

### A consumer purchases a cooktop with these specifications:

- Four burner, 36" cooktop
- Burner output is 60,000 BTU
- The cooktop features a grill
- Installation requirements call for the range hood to be 33" over the range (3" above recommended maximum height)

### Blower CFM Option 1:

(Using the guidelines above) The blower must equal a minimum of 600 CFM (60,000 BTU) + 200 CFM (for Grill requirement) + 100 CFM (for 3" of installation height) = 900 CFM

### Blower CFM Option 2:

(Using the guidelines above) Select a range hood that is a minimum of 3" WIDER than the cooktop, a minimum 600 CFM (60,000 BTU) + 200 CFM (for Grill requirement) = 800 CFM

## Internal, In-Line and Exterior blower specifications table

Model	Mounting	MAX Blower CFM	HVI CFM	Max Cooktop BTU	HVI	Volts	Amps	Rough-In Duct	Inlet/Outlet†	Direction	Motor Type
P5	Internal	530	460V/500H	60,000	Y	120	1.8	3-1/4"x10"	—	V or H	—
P8	Internal	930	850V/900H	95,000	Y	120	3.4	3-1/4"x14"	—	V or H	—
331H††	Exterior	660	600	60,000	Y	120	2.3	10" round	—	—	Single-Speed
332H††	Exterior	880	900	90,000	Y	120	5.8	10" round	—	—	Single-Speed
335††	Exterior	1280	1200	120,000	Y	120	3.0	10" round	—	—	Single-Speed
336††	Exterior	1620	1500	120,000	Y	120	3.8	10" round	—	—	Single-Speed
HLB3††^	In-Line	320	280/260*	40,000	Y	120	2.6	—	8" or 10" round	V or H	Single-Speed
HLB6††	In-Line	670	600/600*	65,000	Y	120	2.9	—	10"/10" round	V or H	Single-Speed
HLB9††	In-Line	890	800/700*	85,000	Y	120	3.0	—	10"/10" round	V or H	Single-Speed
HLB11††	In-Line	1540	1100/1000*	110,000	Y	120	5.0	—	10"/10" round	V or H	Single-Speed

†† Model 332KR Rough-In Kit required for installation with hood series RM60000, 64000 and RMIP (Model 421 10" In-Line damper recommended for Exterior blowers).

\* Straight CFM/Right angled CFM (rated with transitions provided).

† Transitions provided with unit.

^ Not recommended for use with grill applications.



# Range Hood Specifications

SERIES	PAGE	DESCRIPTION	WIDTH (inches)	FINISHES <sup>†</sup> (may not be in all widths)	LIGHTING	BULB INCL.	CONTROL FEATURES	CONTROL TYPE	
<b>CHIMNEY &amp; ISLAND</b>									
BWP2 (450)	12	Chimney Hood	24, 30, 36	SS	Dual LED	yes	3 speed	Soft Touch	
BWP2 (630)	12	Chimney Hood	30, 36	SS	Dual LED	yes	3 speed	Soft Touch	
BWS2	13	Chimney Hood	30	SS, BLS	Dual LED	yes	3 speed	Soft Touch	
BW50SSL	16	Chimney Hood	30, 36	SS	Dual LED	yes	3 speed	Pushbutton	
BWT2304SS	14	Chimney Hood	30	SS	Dual LED	yes	3 speed	Soft Touch	
BWT2304SSB	15	Chimney Hood	30	SS with Black Glass	Dual LED	yes	3 speed	Soft Touch	
E54000	20	Island Hood	35-7/16 x 27-9/16	SS	Halogen Quad 20W JC/G4	yes	Multi-speed Heat Sentry™	Slide	
EI59	21	Island Hood	35-3/16 x 25-9/16	SS	Halogen Quad 35W MR16 GU10	yes	3-speed, Delay-off, Filter indicator, 3-setting light, Heat Sentry™	Electronic Push Optional Remote	
EW54	17	Chimney Hood	30, 36	BLS	Halogen Dual 50W GU10	yes	3-speed, Filter indicator, 2-setting light	Capacitive Touch	
EW56	19	Chimney Hood	30, 35-7/16	SS	Halogen Dual 35W MR16 GU10	yes	3-speed, Delay-off, Filter indicator, 3-setting light, Heat Sentry™	Electronic Push Optional Remote	
EW58	18	Chimney Hood	30, 36	SS	Halogen Dual 35W MR16 GU10	yes	3-speed, Delay-off, Filter indicator, 3-setting light, Heat Sentry™	Electronic Push Optional Remote	
EW43	11	Chimney Hood	24, 30, 36	SS, BLS	Large LED Strip	yes	3 speed	Capacitive Touch	
EW46	10	Chimney Hood	30, 36	SS	Large LED Strip	yes	3 speed	Capacitive Touch	
EW48	9	Chimney Hood	24, 30, 36	WH, SS, BLS	Large LED Strip	yes	3 speed	Capacitive Touch	
<b>HIGH PERFORMANCE</b>									
E60000	24, 25	Professional Style Hood Choice of Internal & External Blowers	30, 36, 42, 48	SS	Halogen 50W Lamps 2/3 MR16 GU10	no	Hi/Lo light	Rotary	
E64000	22, 23	Professional Style Hood Choice of Internal & External Blowers	30, 36, 42, 48	SS	Halogen 50W Lamps 2/3 MR16 GU10	no	Hi/Lo light	Rotary	
EPD61	26, 27	Professional Style Outdoor Chimney Hood	36, 48, 60	SS	Halogen Dual or Tri 50W MR16 GU10	no	3 speed	Rotary	
<b>DOWNDRAFTS</b>									
27000	41	Downdraft	30, 36	SS, (WH, BL)	na	na	Variable speed	Rotary	
28000	41	Downdraft External Blower	30, 36	SS, (WH, BL)	na	na	Variable speed	Rotary	
RMDD	40	Broan Elite Downdraft	30, 36, 48	SS	na	na	Variable speed	Rotary	

\* Mounting Height is measured from the top of the cooktop to the bottom of the hood filter.

\*\* Visible height of Chimney when in the raised position.

\*\*\* Minimum Height is 24" when using optional RMP series backsplash.

† SS=430 Stainless Steel, BL=Black on Black, WW=White with color-matched controls, WH=White with contrasting controls.

†† (Normal Setting).

SERIES	AIR-MOVER TYPE	MOUNT HEIGHT*	VISIBLE SHELL HEIGHT (inches)	CEILING HEIGHT MAX	DUCTING SIZE	FILTERS INCL.	MAX Blower CFM	CFM/SONES VERT. RECT.	CFM/SONES HORIZ. RECT.	CFM/SONES VERT. ROUND	HVI
<b>CHIMNEY &amp; ISLAND</b>											
BWP2 (450)	Centrifugal Blower	24" to 36"	9-11/16	8'-9", Opt. 10'	6" round (V) Non-ducted	Hybrid Baffle	450	—	—	400/8.5 (220/3.0) <sup>††</sup>	Y
BWP2 (630)	Centrifugal Blower	24" to 36"	9-11/16	8'-9", Opt. 10'	6" round (V) Non-ducted	Hybrid Baffle	630	—	—	600/12 (110/1.5) <sup>††</sup>	Y
BWS2	Centrifugal Blower	24" to 36"	3-3/4	8'-9", Opt. 10'	6" round (V) Non-ducted	Hybrid Baffle	450	—	—	400/8.5 (220/3.0) <sup>††</sup>	Y
BW50SSL	Centrifugal Blower	30" to 36"	9-7/8	8'-9", Opt. 10'	6" round (V) Non-ducted	Aluminum	380	—	—	350/8.0 (130/1.5) <sup>††</sup>	Y
BWT2304SS	Centrifugal Blower	24" to 36"	1-9/16	8'-9", Opt. 10'	6" round (V) Non-ducted	Hybrid Baffle	450	—	—	400/8.5 (220/3.0) <sup>††</sup>	Y
BWT2304SSB	Centrifugal Blower	24" to 36"	1-15/16	8'-9", Opt. 10'	6" round (V) Non-ducted	Hybrid Baffle	450	—	—	400/8.5 (220/3.0) <sup>††</sup>	Y
E54000	Centrifugal Blower	24"–30"	3-7/8	8'-9", Opt. 10'	6" round (V) Non-ducted	Aluminum	550	—	—	480/9.5 (230/3.0) <sup>††</sup>	Y
EI59	Centrifugal Blower w/ Make-up Air Damper Interlock	24"–36"	—	8'-9", Opt. 10'	6" round (V) Non-ducted	Aluminum	520	—	—	500/10.5 (200/2.5) <sup>††</sup>	Y
EW54	Centrifugal Blower	24"–30"	—	8'-9", Opt. 10'	6" round (V) Non-ducted, 3-1/4" x 10" (V,H)	Aluminum	650	—	500/12 (180/1.5) <sup>††</sup>	500/10.5 (200/2.5) <sup>††</sup>	Y
EW56	Centrifugal Blower w/ Make-up Air Damper Interlock	24"–36"	—	8'-9", Opt. 10'	6" round (V) Non-ducted	Aluminum	500	—	—	500/10.5 (200/2.5) <sup>††</sup>	Y
EW58	Centrifugal Blower w/ Make-up Air Damper Interlock	24"–36"	—	8'-9", Opt. 10'	6" round (V) Non-ducted	Aluminum	520	—	—	500/10.5 (200/2.5) <sup>††</sup>	Y
EW43	Centrifugal Blower	24" to 30"	2-3/4	8'-9", Opt. 10'	6" round (V) Non-ducted	Aluminum	460	—	—	400/7.5 (180/1.5) <sup>††</sup>	Y
EW46	Centrifugal Blower	24" to 30"	---	8'-9", Opt. 10'	6" round (V) Non-ducted	Aluminum	460	—	—	400/7.5 (180/1.5) <sup>††</sup>	Y
EW48	Centrifugal Blower	24" to 30"	10-7/16	8'-9", Opt. 10'	6" round (V) Non-ducted	Aluminum	460	—	—	400/7.5 (180/1.5) <sup>††</sup>	Y
<b>HIGH PERFORMANCE</b>											
E60000	Centrifugal Blower	24"–30"	18	8'	Internal 3-1/2" x 10" (V,H) or 4-1/2" x 18-1/2" (V,H)	SS Baffle	1290	600/13 (150/1.5) <sup>††</sup> 1200/14.5 (350/2) <sup>††</sup> External 280-1500	600/13 (150/1.5) <sup>††</sup> 1200/14.5 (350/2) <sup>††</sup> External 280-1500	—	Y
E64000	Centrifugal Blower	20"–30" electric*** 24"–30" gas	10	na	Internal 3-1/2" x 10" (V,H) or 4-1/2" x 18-1/2" (V,H)	SS Baffle	1290	600/13 (150/1.5) <sup>††</sup> 1200/14.5 (350/2) <sup>††</sup> External 280-1500	600/13 (150/1.5) <sup>††</sup> 1200/14.5 (350/2) <sup>††</sup> External 280-1500	—	Y
EPD61	Dual Centrifugal Blower	Minimum 36"	18	10'	10" round (V)	SS Baffle	1290	—	—	1100/11.0 (430/2.0) <sup>††</sup>	Y
<b>BUILT-IN</b>											
27000	Centrifugal Blower	na	7**	na	3-1/4" x 10" (V, H)	Aluminum	600	500/na	500/na	—	Y
28000	Centrifugal Blower	na	7**	na	3-1/4" x 10" (V)	Aluminum	600	—	—	280 to 1100: See Md# 332H, or In-Line Blowers	Y
RMDD	Centrifugal Blower	na	9.5	na	3-1/4" x 10"	Stainless Steel	600	500/na	—	—	Y



### HVI-2100 CERTIFICATION

Broan range hoods are tested and certified by the Home Ventilating Institute. This is your assurance that each Broan unit has been tested and found to consistently deliver the air and sound performance specified.



# Range Hood Specifications

SERIES	PAGE	DESCRIPTION	WIDTH (inches)	FINISHES <sup>†</sup> (may not be in all widths)	LIGHTING	BULB INCL.	CONTROL FEATURES	CONTROL TYPE	
<b>POWER PACK INSERTS</b>									
PM390SSP	29	Power Pack	20-1/2	SS	Dual LED	yes	3 speed, Heat Sentry™	Pushbutton	
PM250SSP	30	Power Pack	20-1/2	SS	Dual LED	yes	2 speed	Rocker	
PM250	32, 33	Power Pack	20-1/2	Silver	Candelabra Dual 40W B10E12	no	2 speed	Rocker	
PM390	32, 33	Power Module	20-1/2	Silver	Candelabra Dual 40W B10E12	no	3 speed	Slide	
PM500SS	35	Power Pack	20-1/2	SS	Halogen Dual 20W JC/G4	yes	3 speed	Pushbutton	
RMP1	38, 39	Power Pack	27-9/16	SS	Halogen Dual 50W MR16 GU10	yes	Variable speed Heat Sentry™	Slide	
RMPE	38, 39	Power Pack External Blower	27-9/16	SS	Halogen Dual 50W MR16 GU10	yes	Variable speed Heat Sentry™	Slide	
RMIP	36, 37	Pro-Style Insert	32-3/8, 44-3/8	SS	Halogen Dual 50W PAR20	no	Variable speed Heat Sentry™ Two-Level Lights	Rotary	
<b>ENERGY STAR</b>									
SPE1	44	Spire Range Hood	30, 36	SS	Dual ENERGY STAR® LED	yes	3 speed	Capacitive Touch	
BCSEK1	46	Glacier Range Hood	30	WW, SL, SS, BL	Dual ENERGY STAR® LED	yes	2 speed	Rocker	
BKDEG1	45	Sahale Range Hood	30	WW, SS, BL	Dual ENERGY STAR® LED	yes	3 speed	Capacitive Touch	
PME300	43	Power Module	20-1/2	Silver	Dual compact 13W fluorescent bulbs G24Q-1	yes	3 speed	Slide	
<b>UNDER CABINET</b>									
15000	34	Slide Out Hood	30, 36	WW, BL, SS	24" Fluorescent F20T12	no	Variable speed Heat Sentry™	Slide	
37000	67	Range Hood Shell	24, 30, 36	WW, BT, SS	na	na	na	na	
40000/BUEZO	64	Range Hood	21, 24, 30, 36, 42	WW, BT, SS, BL	Single 75W Incandescent	no	2 speed	Rocker	
41000/BUEZ1	65	Range Hood	21, 24, 30, 36, 42	WW, BT, SS, BL	Single 75W Incandescent	no	2 speed	Rocker	
42000/BUEZ2	64	Range Hood	24, 30, 36, 42	WW, BT, SS, BL	Single 75W Incandescent	no	2 speed	Rocker	
43000/BUEZ3	65	Range Hood	30, 36	WW, BC, SS, BL	Enclosed Single 75W Incandescent	no	2 speed	Rocker	
46000	63	Range Hood	24, 30, 36, 42	WH, BT, SS, BL, WW	Single 75W Incandescent	no	Hi/Lo light	Rotary dial	
BXT1	62	Range Hood	30	WW, BL, SS	Single 4.5W LED GU10	yes	2 speed	Rocker	
ALT4	49	Alta Range Hood	30, 36	SS	Dual LED	yes	3-Speed	Infrared Touch	
ALT3	50	Alta Range Hood	30, 36	SS	Dual LED	yes	3-Speed	Capacitive Touch	
ALT2	51	Alta Range Hood	30, 36	BL, BLS, SS, WW	Dual LED	yes	3-Speed	Capacitive Touch	

\* Mounting Height is measured from the top of the cooktop to the bottom of the hood filter.

† SS=430 Stainless Steel, BL=Black on Black, BLS=Black Stainless Steel, SL=Slate, BT=Bisque w/Black controls, BC=Bisque on Bisque, WW=White with color-matched controls, WH=White with contrasting controls.

†† (Normal Setting).

††† RMIP Series requires 332KR Rough-In Kit when used with Exterior or In-Line blowers.

SERIES	AIR-MOVER TYPE	MOUNT HEIGHT*	VISIBLE SHELL HEIGHT (inches)	CEILING HEIGHT MAX	DUCTING SIZE	FILTERS INCL.	MAX Blower CFM	CFM/ SONES VERT. RECT.	CFM/ SONES HORIZ. RECT.	CFM/ SONES VERT. ROUND	HVI
<b>POWER PACKS</b>											
PM390SSP	Dual Centrifugal Blower	24"–30"	9.5	na	6" round (V)	Aluminum	440	—	—	390/6.5 (250/2.5) <sup>††</sup>	Y
PM250SSP	Fan	24"–30"	2-1/2	na	6" round (V)	Aluminum	300	—	—	250/8.0	Y
PM250	Fan	24"–30"	3-5/8	na	7" round (V) Non-ducted kit 356NDK	Aluminum w/ Light Lens	300	—	—	250/8.0	Y
PM390	Centrifugal Blower	24"–30"	3-5/8	na	6" round (V) Non-ducted kit 357NDK	Aluminum w/ Light Lens	440	—	—	390/6.5 (250/2.5) <sup>††</sup>	Y
PM500SS	Centrifugal Blower	22"–30"	Flush	na	6" round (V) Non-ducted kit 359NDK	Aluminum	550	—	—	500/9.0	Y
RMP1	Centrifugal Blower	24"–30"	Flush	na	6" round (V)	Aluminum	550	—	—	400/9.0	Y
RMPE	Centrifugal Blower	24"	Flush	na	8" round (V)	Aluminum	400	—	—	280 to 1500 See Exterior or In-Line Blowers	Y
RMIP	Centrifugal Blower	24"–30"	Flush	na	See selected blower on pages 74–75 <sup>†††</sup>	SS & Aluminum	460	460 to 850 See Md# P5, P8	—	—	Y
<b>ENERGY STAR</b>											
SPE1	Centrifugal Blower	24"–30"	9	na	3-1/4" x 10" or 14" (V,H) 7" round	Hybrid Baffle	650	460/8.0 (130/<0.3) <sup>††</sup>	510/7.5 (130/<0.3) <sup>††</sup>	470/7.5 (140/<0.3) <sup>††</sup>	Y
BCSEK1	Axial	18"–24"	6	na	3-1/4" x 10" (V, H) 7" round	Open-mesh	300	220/5.0 (130/1.5) <sup>††</sup>	210/5.0 (110/1.5) <sup>††</sup>	240/5.0 (150/1.5) <sup>††</sup>	Y
BKDEG1	Axial	18"–24"	5	na	3-1/4" x 10" (V, H) 7" round	Deluxe Micro-mesh, elongated pattern	375	230/6.0 (120/1.5) <sup>††</sup>	230/6.5 (110/1.5) <sup>††</sup>	260/5.5 (130/1.5) <sup>††</sup>	Y
PME300	Centrifugal Blower	24"–30"	3-5/8	na	6" round (V)	Aluminum	350	—	—	290/5.0 (130/0.5) <sup>††</sup>	Y
<b>UNDER CABINET</b>											
15000	Dual Centrifugal Blower	18"–24"	1	na	3-1/4" x 10" (V)	MicroFoam	390	300/4.5	—	—	Y
37000	na	18"–24"	6	na	Shell only	na	na	—	—	—	—
40000/BUEZO	Fan	18"–24"	6	na	3-1/4" x 10" (V, H)	Aluminum	210	160/6.5	160/6.5	—	Y
41000/BUEZ1	Fan	18"–24"	6	na	Non-ducted	Charcoal	na	—	—	—	—
42000/BUEZ2	Fan	18"–24"	6	na	7" round (V)	Aluminum	230	—	—	190/6.0	Y
43000/BUEZ3	Fan	18"–24"	6	na	3-1/4" x 10" (V, H) 7" round (V) Non-ducted	Aluminum w/ Light Lens	260	190/7.0	160/7.0	220/8.0	Y
46000	Fan	18"–24"	6	na	3-1/4" x 10", 7" round Non-ducted	Aluminum	260	190/7.5 (100/2.5) <sup>††</sup>	190/7.5 (100/3.0) <sup>††</sup>	220/7.5 (100/2.0) <sup>††</sup>	Y
BXT1	Fan	20"–25"	6	na	3-1/4" x 10" (V,H) 7" round	Aluminum	270	200/7.0 (100/2.5) <sup>††</sup>	170/7.5 (70/2.5) <sup>††</sup>	250/7.0 (150/2.0) <sup>††</sup>	Y
ALT4	Dual Centrifugal Blower	24"–30"	5	na	3-1/4" x 10" or 14" (V,H) 7" round	Peripheral	650	380/7.0 (110/<0.3) <sup>††</sup>	430/7.0 (110/<0.3) <sup>††</sup>	390/7.0 (120/<0.3) <sup>††</sup>	Y
ALT3	Dual Centrifugal Blower	18"–24"	5	na	3-1/4" x 10" (V,H) 7" round	Hybrid Baffle	450	360/6.0 (140/0.4) <sup>††</sup>	400/5.5 (150/0.4) <sup>††</sup>	370/5.5 (140/0.4) <sup>††</sup>	Y
ALT2	Axial	18"–24"	5	na	3-1/4" x 10" (V,H) 7" round	Deluxe Micro-mesh, oval pattern	375	230/6.0 (120/1.5) <sup>††</sup>	230/6.5 (110/1.5) <sup>††</sup>	260/5.5 (130/1.5) <sup>††</sup>	Y



### HVI-2100 CERTIFICATION

Broan range hoods are tested and certified by the Home Ventilating Institute. This is your assurance that each Broan unit has been tested and found to consistently deliver the air and sound performance specified.

# Range Hood Specifications

SERIES	PAGE	DESCRIPTION	WIDTH (inches)	FINISHES <sup>†</sup> (may not be in all widths)	LIGHTING	BULB INCL.	CONTROL FEATURES	CONTROL TYPE	
ALT1	52	Alta Range Hood	30, 36	BL, SS, WW	Dual Halogen	yes	2-Speed	Rocker	
BCDF1	57	Glacier Range Hood	30, 36, 42	SS, BLS	Dual LED	yes	3 speed	Capacitive Touch	
BCDJ1	56	Glacier Range Hood	30, 36, 42	WH, SS, BL	Dual LED	yes	3 speed	Electronic Pushbutton	
BCSD1	58	Glacier Range Hood	24, 30, 36, 42	WW, BC, SS, BL	Dual Halogen	no	2 speed	Rocker	
BKDB1	59	Sahale Range Hood	30, 36	WW, SS, BL	Dual LED	yes	3 speed	Capacitive Touch	
BKSA1	61	Sahale Range Hood	30	WW, SS, BL	Dual Halogen	no	2 speed	Rocker	
BKSH1	60	Sahale Range Hood	30	WW, SS, BL	Dual Halogen	yes	2 speed	Deluxe Rocker	
BPDP1	55	Spire Range Hood	30, 36, 42, 48	SS	Dual LED	yes	2 speed	Deluxe Rocker	
TEN1	54	Tenaya Range Hood	30, 36	BL, SS, WW	Dual Halogen	yes	2-Speed	Rocker	
TEN2	53	Tenaya Range Hood	30, 36, 42	BL, SS, WW	Dual LED	yes	3 speed	Capacitive Touch	
F40000	66	Range Hood	24, 30, 36, 42	WH, AL, SS, BL, WW, BC	Single 75W Incandescent	no	2 speed	Rocker	
<b>BLOWERS</b>									
335	74, 75	***Exterior Blower	na	na	na	na	na	na	
336	74, 75	***Exterior Blower	na	na	na	na	na	na	
331H	74, 75	***Exterior Blower	na	na	na	na	na	na	
332H	74, 75	***Exterior Blower including 28000	na	na	na	na	na	na	
HLB3	74, 75	***In-Line Blower	na	na	na	na	na	na	
HLB6	74, 75	***In-Line Blower	na	na	na	na	na	na	
HLB9	74, 75	***In-Line Blower	na	na	na	na	na	na	
HLB11	74, 75	***In-Line Blower	na	na	na	na	na	na	
P5	74, 75	Internal Blower for RMIP	na	na	na	na	na	na	
P8	74, 75	Internal Blower for RMIP	na	na	na	na	na	na	

<sup>†</sup> SS=430 Stainless Steel, BL=Black on Black, BLS=Black Stainless Steel, SL=Slate, BT=Bisque w/Black controls, BC=Bisque on Bisque, WW=White with color-matched controls, WH=White with contrasting controls.

<sup>††</sup> (Normal Setting).

<sup>†††</sup> External blower for E60000, E64000, 61000EX, 63000EX, RMPE, RMIP, RMDDEX and E66000 Series.



SERIES	AIR-MOVER TYPE	MOUNT HEIGHT*	VISIBLE SHELL HEIGHT (inches)	CEILING HEIGHT MAX	DUCTING SIZE	FILTERS INCL.	MAX Blower CFM	CFM/SONES VERT. RECT.	CFM/SONES HORIZ. RECT.	CFM/SONES VERT. ROUND	HVI
ALT1	Axial	18"-24"	5	na	3-1/4" x 10" (V,H) 7" round	Micro-mesh	300	220/5.0 (130/1.5) <sup>††</sup>	210/5.0 (110/1.5) <sup>††</sup>	240/5.0 (140/1.5) <sup>††</sup>	Y
BCDF1	Axial	18"-24"	6	na	3-1/4" x 10" (V, H) 7" round	Micro-mesh	375	240/6.0 (130/1.5) <sup>††</sup>	240/6.0 (110/1.5) <sup>††</sup>	260/5.5 (140/2.0) <sup>††</sup>	Y
BCDJ1	Dual Centrifugal Blower	18"-24"	6	na	3-1/4" x 10" (V, H) 7" round	Deluxe Micro-mesh, circle pattern	450	360/6.0 (140/0.4) <sup>††</sup>	400/5.5 (150/0.4) <sup>††</sup>	380/5.5 (150/0.4) <sup>††</sup>	Y
BCSD1	Axial	18"-24"	6	na	3-1/4" x 10" (V, H) 7" round	Open-mesh	300	220/5.0 (130/1.5) <sup>††</sup>	210/5.0 (110/1.5) <sup>††</sup>	240/5.0 (150/1.5) <sup>††</sup>	Y
BKDB1	Axial	18"-24"	5	na	3-1/4" x 10" (V, H) 7" round	Micro-mesh	300	220/5.0 (130/1.5) <sup>††</sup>	210/5.0 (110/1.5) <sup>††</sup>	240/5.0 (140/1.5) <sup>††</sup>	Y
BKSA1	Axial	18"-24"	5	na	3-1/4" x 10" (V, H) 7" round	Open-mesh	300	220/5.0 (130/1.5) <sup>††</sup>	210/5.0 (110/1.5) <sup>††</sup>	240/5.0 (150/1.5) <sup>††</sup>	Y
BKSH1	Axial	18"-24"	5	na	3-1/4" x 10" (V, H) 7" round	Micro-mesh	300	220/5.0 (130/1.5) <sup>††</sup>	210/5.0 (110/1.5) <sup>††</sup>	240/5.0 (140/1.5) <sup>††</sup>	Y
BPDP1	Dual Centrifugal Blower	18"-24"	9	na	3-1/4" x 10" (V, H) 7" round	Hybrid Baffle	450	360/6.0 (140/0.4) <sup>††</sup>	400/5.5 (150/0.4) <sup>††</sup>	370/5.5 (140/0.4) <sup>††</sup>	Y
TEN1	Axial	18"-24"	5	na	3-1/4" x 10" (V,H) 7" round	Open-mesh	300	220/5.0 (130/1.5) <sup>††</sup>	210/5.0 (110/1.5) <sup>††</sup>	240/5.0 (150/1.5) <sup>††</sup>	Y
TEN2	Axial	18"-24"	5	na	3-1/4" x 10" (V,H) 7" round	Micro-mesh	375	240/6.0 (130/1.5) <sup>††</sup>	240/6.0 (110/1.5) <sup>††</sup>	260/5.5 (140/2.0) <sup>††</sup>	Y
F40000	Fan	18"-24"	6	na	3-1/4" x 10" (V, H) 7" round (V) Non-ducted	Aluminum	230	160/6.5	160/6.5	190/6.5	Y

### BLOWERS

335	Centrifugal Blower	na	na	na	10" round	na	1280	—	—	1200/na	Y
336	Centrifugal Blower	na	na	na	10" round	na	1620	—	—	1500/na	Y
331H	Centrifugal Blower	na	na	na	10" round	na	660	—	—	600/na	Y
332H	Centrifugal Blower	na	na	na	10" round	na	880	—	—	900/na	Y
HLB3	Centrifugal Blower	na	na	na	Inlet 8" or 10" round Outlet 8" round	na	320	—	—	S280(H)/ S260(V)	Y
HLB6	Centrifugal Blower	na	na	na	Inlet 10" round Outlet 10" round	na	670	—	—	S600(H)/ S600(V)	Y
HLB9	Centrifugal Blower	na	na	na	Inlet 10" round Outlet 10" round	na	890	—	—	S800(H)/ S700(V)	Y
HLB11	Centrifugal Blower	na	na	na	Inlet 10" round Outlet 10" round	na	1540	—	—	S1100(H)/ S1000(V)	Y
P5	Centrifugal Blower	na	na	na	3-1/4" x 10" (V, H)	na	530	460/10.5	500/10	—	Y
P8	Dual Centrifugal Blower	na	na	na	3-1/4" x 14" (V, H)	na	930	850/10.5	900/10	—	Y



### HVI-2100 CERTIFICATION

Broan range hoods are tested and certified by the Home Ventilating Institute. This is your assurance that each Broan unit has been tested and found to consistently deliver the air and sound performance specified.

# Overture™

## Now you can monitor, measure and manage the air quality in your home.

Overture™ is a simple solution that automatically manages indoor air quality. Comprised of a wall switch, a room sensor and a smart plug, Overture™ monitors humidity, TVOCs, CO<sub>2</sub> and temperature. When any of these factors exceed normal levels, Overture™ devices automatically start your compatible range hood and ventilation fans to exhaust bad air. And with the Smart Plug controlling your air supply unit, fresh air is introduced concurrently.



 Fresh Air     Above Level     Polluted Air     Airflow

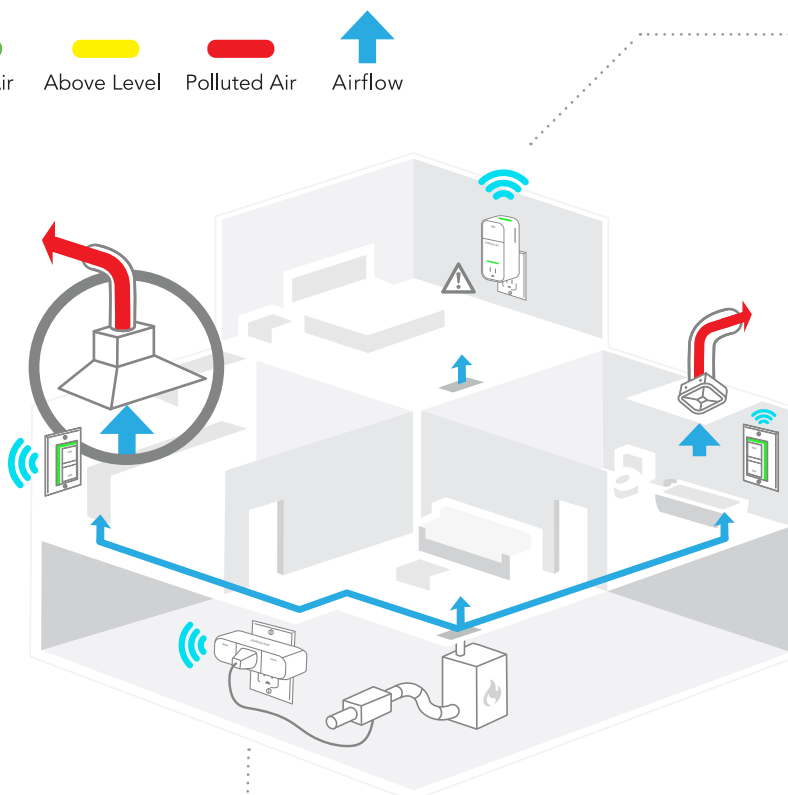

The Overture™ app enables you to monitor air quality from anywhere, anytime. Monitor any room—even in different homes.



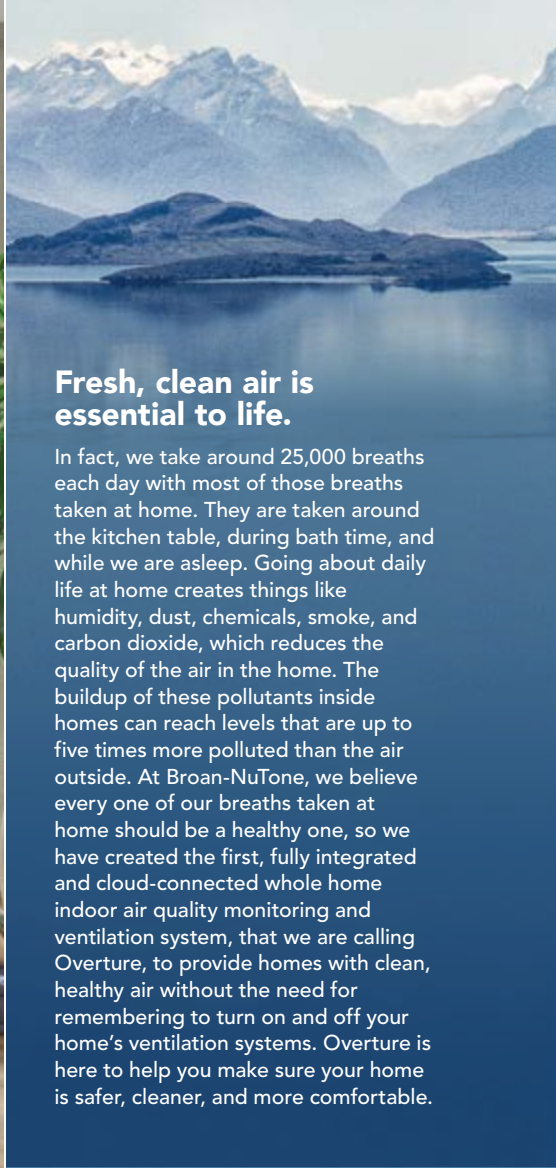

## Fresh, clean air is essential to life.

In fact, we take around 25,000 breaths each day with most of those breaths taken at home. They are taken around the kitchen table, during bath time, and while we are asleep. Going about daily life at home creates things like humidity, dust, chemicals, smoke, and carbon dioxide, which reduces the quality of the air in the home. The buildup of these pollutants inside homes can reach levels that are up to five times more polluted than the air outside. At Broan-NuTone, we believe every one of our breaths taken at home should be a healthy one, so we have created the first, fully integrated and cloud-connected whole home indoor air quality monitoring and ventilation system, that we are calling Overture, to provide homes with clean, healthy air without the need for remembering to turn on and off your home's ventilation systems. Overture is here to help you make sure your home is safer, cleaner, and more comfortable.



**Smart Wall Control**  
Model BIAQWC1



**Smart Room Sensor**  
Model BIAQRS1



**Smart Plug**  
Model BIAQSP1



Scan this code to learn more about Overture™ and the complete range of compatible ventilation solutions.



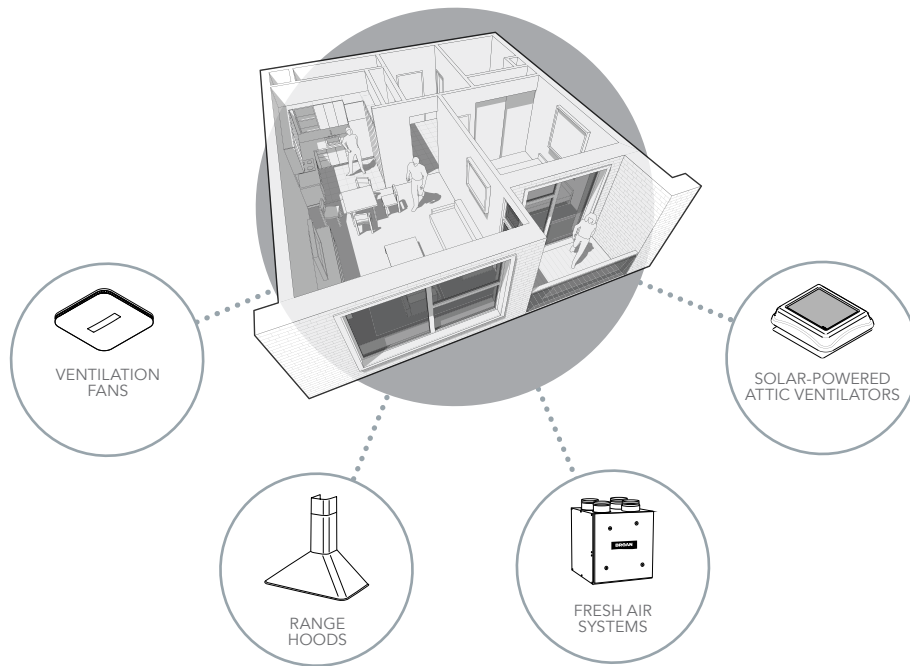

THE LEADER IN RESIDENTIAL INDOOR AIR QUALITY.  
**COME HOME TO FRESH AIR.**

Broan-NuTone® is America's leading brand of residential ventilation products including range hoods, ventilation fans, fresh air systems, electric and solar-powered attic ventilators.



**BROAN-NUTONE.COM** | **800-558-1711** | 926 WEST STATE STREET, HARTFORD, WISCONSIN 53027